

# ESTATE EQUIPMENT CATALOGUE



WESTWARD PARTS

# Westward has the part!

**Westward has the part!** That's our commitment to you, and that's what sets us apart. Westward Parts has over 48 years of expertise with all makes of agricultural parts, sprayer parts, sprayers, as well as ground maintenance and estate equipment. Our Canadian dealers are served from three different warehouse locations across the country. Westward Parts offers our dealers the most comprehensive product portfolio and exclusive product offerings. And it will all be delivered on time, with an enjoyable customer service experience that won't let you down.

## Westward Parts Distribution:

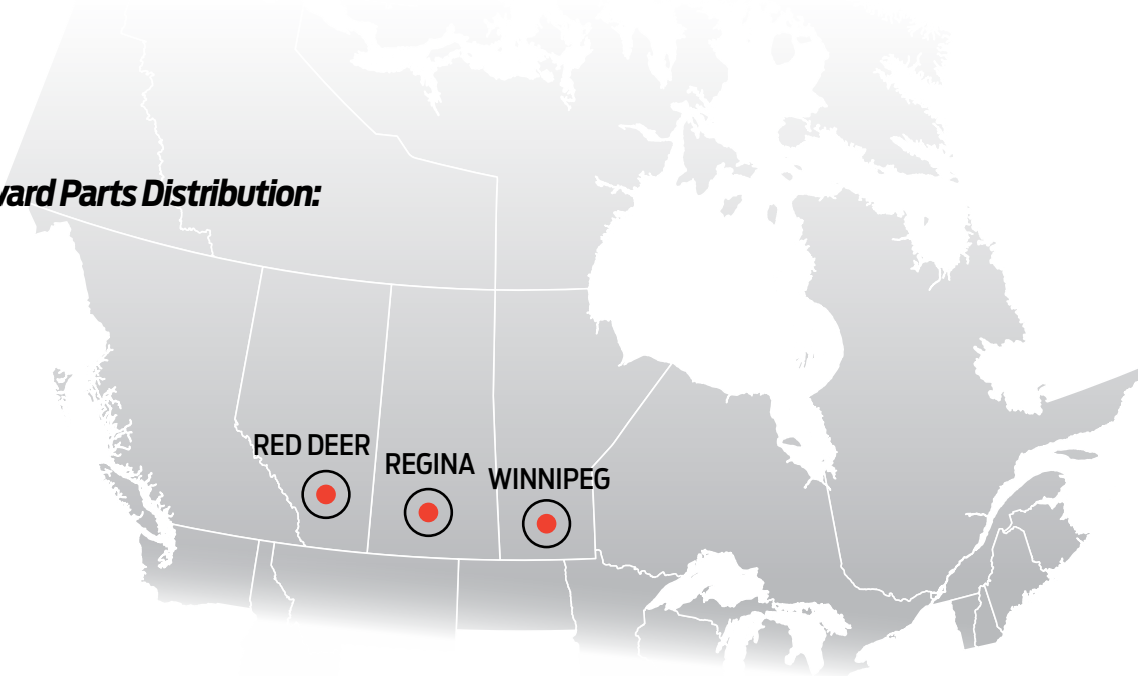

**RED DEER**  
6517 - 67 Street  
Red Deer, AB T4P 1A3  
Fax: 1-800-661-4508

**REGINA**  
201 Henderson Drive  
Regina, SK S4N 7E2  
Fax: 1-800-721-2977

**WINNIPEG**  
1435 St. James Street  
Winnipeg, MB R3H 0W9  
Fax: 1-800-257-8338

**1-888-937-7278**

**WWW.WESTWARDPARTS.COM**



# ESTATE EQUIPMENT

## Index

### POWER EQUIPMENT

Inverters .....	2-3
Generators .....	4-7
Pressure Washers .....	7-8
Cordless Tools .....	9-10

### FENCING EQUIPMENT

Augers & Options .....	15-16
Hydraulic Post Drivers .....	16
Post Hole Diggers .....	12-15

### HAY & BALE HANDLING EQUIPMENT

3 Point Hay Rakes .....	24
Bale Clamps .....	23
Bale Spears .....	18-21
Bale Spin Off .....	24
Bale Unroller .....	23
Pull-Type Wheel Rakes .....	25
Replacement Bale Spears .....	22
Replacement Tines and Rake Wheels .....	25

### LAWN & GARDEN

Aerators .....	30-31
Carts .....	31-34
Discs .....	36
Ice Melt .....	58
Lawnkeeper .....	28-29
Lawn Fertilizer .....	58
Lawn Rollers .....	37-38
Lawn Sweepers .....	28-29, 41-42
Leaf Blade .....	38
Mowers - Economy Cutter .....	44
Mowers - Round Back Cutters .....	44
Mowers - Heavy Duty Cutters .....	45
Mowers - Heavy Duty Double Cutters .....	45
Mowers - Variable Offset Rotary Cutters .....	46
Mowers - Skid Steer Mounted Cutters .....	46
Mowers - Heavy Duty Finishing .....	47
Smart Series .....	39-40
Spreaders .....	48-54, 56-57
Tine Dethatcher .....	35
Tiller .....	36
Vacs .....	43

### MATERIAL MOVEMENT

Box Scraper .....	71
Bucket Forks .....	63
Bucket Tooth Bar .....	70
Cement Mixer .....	71
Heavy Duty Rear Blades .....	67-68
Landscape Rakes .....	70
Pallet Forks .....	60-62
Quick Hitches .....	72
Skid Steer Attachments .....	63-65
Rear Blades .....	66
Snow Blades .....	69
Snow Pusher .....	68
Skid Steer Tracks .....	73-74
Standard Rear Blades .....	66

### TILLAGE

ArenaVator III .....	78
Arena Groomers .....	79
Harrows - Flexible .....	76-77
Harrows - Diamond .....	77
Heavy Duty Core Aerators .....	81
Rakes .....	82
Rototillers - 3 Pt. Hitch .....	83-84
Single Shank .....	81

### SPRAYERS & ACCESSORIES

Backpack Sprayers - Manual .....	88-90
Backpack Sprayers - Battery Powered .....	92-93
Backpack & Handheld Sprayers .....	91
Compression Sprayers .....	86-87
Industrial Concrete Sprayer .....	91
Hand Held Sprayer .....	86
Vacuum Pump .....	93
Westward Parts & FIMCO Catalogue .....	94

# ESTATE EQUIPMENT

## Index



**NORWESCO TANKS**

Flat Bottom Tanks ..... 97  
 Horizontal Leg Tanks ..... 98  
 Indoor Water Tanks ..... 98  
 Low Profile Tanks ..... 97  
 Pickup Truck Tanks ..... 96  
 Vertical Storage Tanks ..... 96

**WATER, TRANSFER & TRASH PUMPS**

3" Transfer Pumps ..... 103  
 AC Pumps ..... 113-114  
 Chemical Transfer Pump ..... 104  
 DC Pumps ..... 110-113  
 Fuel Transfer Pump ..... 109  
 Hose ..... 116  
 Hydraulic Pumps ..... 101  
 Meters ..... 117  
 Mini-Bulk Pumps ..... 100  
 Nozzles ..... 115  
 Poly Pump with Engine ..... 102  
 Pressure Washer Hose Reels ..... 118  
 Transfer Pump System ..... 100  
 Trash Pumps ..... 108  
 Water Transfer Pump ..... 105-107

**SHOP SUPPLIES**

Bungee Cords ..... 131  
 Brinks Padlocks ..... 129  
 Cab'N Fresh ..... 120  
 Car Care Products ..... 123-126  
 Hand Sanitizer ..... 121  
 Refrigerant & Accessories ..... 127-128  
 Shop Supplies ..... 120-122  
 Tie-Down Assortment Kit ..... 130  
 Tub O'Towels ..... 120  
 Worx Hand Cleaner ..... 121  
 WIPECO Gloves ..... 132

# POWER EQUIPMENT

- INVERTERS
- GENERATORS
- PRESSURE WASHERS
- CORDLESS TOOLS & ACCESSORIES



**WESTWARD PARTS**

## Inverters



### **iGen1200 Inverter** *Fuel Efficient - Up To 9 Hour Run Time*

#### STANDARD FEATURES

- 1200 peak watts, 1000 running watts and runs for up to 9 hours on a 0.8 gal. gas tank.
- Enhanced fuel efficiency - variable engine speeds allow 30% to 50% higher fuel efficiency than a traditional generator.
- Lightweight and compact design - the iGen1200 weighs 33 lb. and features a built-in carry handle for easy transportation.
- Super quiet - as low as 52 dBA with double-insulated acoustic enclosure, asymmetrical cooling fans, and low tone mufflers to reduce operating noise.
- Safely powers sensitive electronics such as laptop computers, cell phones, and more with less than 3% THD.
- Features 2 USB ports (5-Volt DC) and a 120-Volt AC 20 Amp household duplex receptacles.
- 3-year warranty and lifetime technical support through Westinghouse's support network.
- All Westinghouse portable generators are functionally tested in the factory and may contain minimum residual oil and/or fuel odor.



Part No.	Description	Weight (Dry)
MISIGEN1200	Inverter - iGen 1200	33 lbs.

### **iGen2200 Inverter** *Perfect for Camping, Tailgating, RV's, Home Backup and More!*

#### STANDARD FEATURES

- 2,200 Peak Watts, 1,800 Running Watts
- Fuel Efficient - Up to 12 Hour Run Time (1.2 gal)
- Super Quiet - Less Noise than Normal Conversation
- Safe for Electronics - Inverter Technology
- Light Weight - Only 46 lbs
- 3-year warranty and lifetime technical support through Westinghouse's support network.



Part No.	Description	Weight (Dry)
MISIGEN2200	Inverter - iGen 2200	46 lbs.

# Inverters



## **iGen2500 Inverter** *Perfect for Camping, Tailgating, RV's, Home Backup and More!*

### STANDARD FEATURES

- 2500 peak watts, 2200 running watts and runs for up to 10 hours on a 1.0 gal. gas tank.
- Enhanced fuel efficiency - variable engine speeds allow 30% to 50% higher fuel efficiency than a traditional generator.
- Lightweight and compact design - the iGen2500 weighs 48 lb. and features a built-in carry handle for easy transportation.
- Real-time LED display with runtime, remaining fuel, load/output, volts and lifetime hours data.
- Super quiet - as low as 52 dBA with double-insulated acoustic enclosure, asymmetrical cooling fans, and low tone mufflers to reduce operating noise.
- Safely powers sensitive electronics such as laptop computers, cell phones, and more with less than 3% THD.
- (2) 120V 5-20R standard household outlets and (2) 5V USB ports with rubber outlet covers.
- 3-year warranty and lifetime technical support through Westinghouse's support network.
- All Westinghouse portable generators are functionally tested in the factory and may contain minimum residual oil and/or fuel odor.



Part No.	Description	Weight (Dry)
MISIGEN2500	Inverter - iGen 2500	48 lbs.

## **iGen4500 Inverter** *Perfect for Camping, Tailgating, RV's, Home Backup and More!*

### STANDARD FEATURES

- 4500 peak watts, 3700 running watts and runs for up to 18 hours on a 3.4 gal. gas tank.
- Enhanced fuel efficiency - variable engine speeds allow 30% to 50% higher fuel efficiency than a traditional generator.
- Compact and powerful design - features telescoping handle and never-flat wheels for easy portability at 98 lb.
- Remote start (key fob) and push button start make this generator convenient to operate.
- Super quiet - as low as 52 dBA with double-insulated acoustic enclosure, asymmetrical cooling fans, and low tone mufflers to reduce operating noise
- Safely powers sensitive electronics such as laptop computers, cell phones and more.
- Real-time LED display with runtime, remaining fuel, load/output, volts and lifetime hours data.
- RV Ready TT-30R outlet keeps this compact generator versatile for campgrounds, tailgates, and other outdoor festivities.
- 3-year warranty and lifetime technical support through Westinghouse's support network.



Part No.	Description	Weight (Dry)
MISIGEN4500	Inverter - iGen4500	98 lbs.

# Generators



## WGen3600V *Perfect for Camping or Home Backup*

### STANDARD FEATURES

- 3,600 running watts, 4,650 peak watts with recoil start.
- Runs for up to 13.5 hours on a 4 gal. fuel tank with built-in fuel gauge.
- Powered by a 212cc 4-Stroke OHV Westinghouse Engine constructed with a durable cast iron sleeve.
- Compact and portable at 99 lb. with as low as 68 dBA operating volume.
- (1) 120-Volt duplex household outlets, (1) L5-30R, and (1) TT-30R RV receptacle with rubber outlet covers.
- Safe and convenient with automatic low oil shutdown, automatic voltage regulation, and overload protection.
- All Westinghouse portable generators are functionally tested in the factory and may contain minimum residual oil and/or fuel odor.
- 3-year warranty and lifetime technical support through Westinghouse's support network.



Built-in  
Fuel Gauge



Part No.	Description	Weight (Dry)
MISWGEN3600V	Generator - WGen 3600V	99 lbs.

## WGen3600DF *Remote Start with Dual Fuel Technology*

### STANDARD FEATURES

- Perfect as a portable power solution for travel trailers or a backup power source at home.
- 3,600 running watts, 4,650 peak watts (gasoline); 3,240 running watts, 4,180 peak watts (propane).
- Runs for up to 13.5 hours on a 4 gal. fuel tank with built-in fuel gauge; up to 10.5 hours on a 20 lb. propane tank.
- Powered by a 212cc 4-Stroke OHV Westinghouse Engine constructed with a durable cast iron sleeve.
- Push-Button Electric Start pairs with key fob and is backed by emergency recoil start.
- Dual fuel operation easily switches from gas to propane without shutting off unit.
- Weighing 109 lb. with as low as 68 dBA operating volume
- (1) 120-Volt duplex household outlets, (1) L5-30R, and (1) TT-30R RV Ready receptacle with rubber outlet covers.
- All Westinghouse portable generators are functionally tested in the factory and may contain minimum residual oil and/or fuel odor.
- 3-year warranty and lifetime technical support through Westinghouse's support network.



Part No.	Description	Weight (Dry)
MISWGEN3600DF	Generator WGen 3600DF	109 lbs.



# Generators



**WGen5300V** *Perfect as a backup power source at home or portable power solution for RVs*

**STANDARD FEATURES**

- 5,300 running watts and 6,600 peak watts with recoil start
- Runs for up to 13.5 hours on a 4.7 gal. fuel tank with built-in fuel gauge
- Powered by a tough 274cc 4-Stroke OHV Westinghouse Engine constructed with a durable cast iron sleeve
- (1) 5-20R household duplex outlets, (1) Transfer Switch Ready L14-30R 120/240V twist-lock, and (1) RV Ready 120V TT-30R receptacle with rubber outlet covers
- 120/240 Volt Selector Switch allows for more flexible power draw per outlet
- VFT display gives you real time updates with the voltage output, frequency, and lifetime hours
- Safe and convenient with automatic low oil shutdown, automatic voltage regulation, and overload protection
- Compact hardened steel frame with foam grip handle and rugged never-flat wheels make portability easy
- All Westinghouse portable generators are functionally tested in the factory and may contain minimum residual oil and/or fuel odor



Part No.	Description	Weight (Dry)
MISWGEN5300V	Generator - WGen 5300V	132.5 lbs.

**WGen7500** *Perfect as a backup power source at home or a dependable source of portable power*

**STANDARD FEATURES**

- 7,500 running watts, 9,500 peak watts
- Runs for up to 11 hours on a 6.6 gal. fuel tank with built-in fuel gauge
- Powered by a high performance 420cc 4-Stroke OHV Westinghouse Engine constructed with a durable cast iron sleeve
- Push-Button Electric Start pairs with remote start key fob and is backed by emergency recoil start
- Weighing 196 lb. with as low as 72 dBA operating volume
- (2) GFCI 5-20R household duplex outlets and (1) Transfer Switch Ready L14-30R 120/240-Volt twist-lock receptacle with rubber outlet covers
- VFT display gives you real time updates with the voltage output, frequency, and lifetime hours
- Safe and convenient with automatic low oil shutdown, automatic voltage regulation, and overload protection
- All Westinghouse portable generators are functionally tested in the factory and may contain minimum residual oil and/or fuel odor



Part No.	Description	Weight (Dry)
MISWGEN7500	Generator - WGen 7500	196 lbs.

# Generators



## **WGen7500DF** *Dual Fuel, Transfer and ST Switch Ready, Ideal for Home Backup*

### STANDARD FEATURES

- 7,500 running watts and 9,500 peak watts (gasoline); 8,550 peak watts and 6,750 running watts (propane).
- Runs for up to 11 hours on a 6.6 gal. fuel tank with built-in fuel gauge; up to 8 hours on a 20 lb. propane tank.
- Powered by a high performance 420cc 4-Stroke OHV Westinghouse Engine constructed with a durable cast iron sleeve.
- Push-Button Electric Start pairs with key fob and is backed by emergency recoil start.
- Dual fuel operation easily switches from gas to propane without shutting off unit.
- Weighing 192 lb. with as low as 72 dBA operating volume. (2) GFCI 5-20R household duplex outlets and (1) Transfer Switch Ready L14-30R 120/240-Volt twist-lock receptacle with rubber outlet covers.
- VFT display gives you real time updates with the voltage output, frequency, and lifetime hours.
- 3-year warranty and lifetime technical support through Westinghouse's support network.
- All Westinghouse pressure washers are functionally tested in the factory and may contain minimum residual oil and/or fuel odor.



Part No.	Description	Weight (Dry)
MISWGEN7500DF	Generator - WGen 7500DF	192 lbs.

## **WGen7500V** *Dual Fuel, Transfer and ST Switch Ready, Ideal for Home Backup*

The Westinghouse WH7500v is a durable and easy-to-use solution to providing a backup power supply to your home during a blackout or power outage. Showcasing electric start, the WH7500v produces 7,500 peak watts and 6,000 running watts from a powerful 420cc 4-Stroke OHV Westinghouse Engine constructed for durability and reliability. Running for up to 18 hours on a 6.6 gal. (25L) tank of gas, it's equipped with a built-in fuel gauge, automatic low oil shutdown, and GFCI household outlets. The L14-30R outlet is Transfer Switch Ready, conveniently connecting straight to your home for total household power, eliminating the hassle for annoying extension cords or power strips. The intuitive control panel includes the VFT Data Center to share real-time updates on maintenance information, making it easy to care for the WH7500v and ensuring a long life with lasting utility. The hardened-steel frame with added roll bars, foam grip handle, and never-flat wheels lets you easily transport this generator on the go while rubber outlet covers provide added protection from the environment.



### STANDARD FEATURES

- Ideal for emergency home backup or as a portable power source
- Transfer Switch Ready L14-30R and household GFCI 120V outlets

Part No.	Description	Weight (Dry)
MISWH7500V	Generator - WGen 7500V	198 lbs.

# Generators



**WGen 10000** Dual Fuel, Portable Generator

The Westinghouse WH10000DF Dual Fuel Portable Generator is a durable and easy-to-use solution to providing a backup power supply to your home during a blackout or power outage. The WH10000DF is a dual fuel generator that operates on gasoline or propane (LPG). Showcasing electric start, the WH10000DF produces 10,000 peak watts and 9,000 running watts from a powerful 420cc 4-Stroke OHV Westinghouse Engine constructed for durability and reliability. Running for up to 18 hours on a 6.6 gal. (25L) tank of gas, it's equipped with a built-in fuel gauge, automatic low oil shutdown, and GFCI household outlets. The L14-30R outlet is Transfer Switch Ready, conveniently connecting straight to your home for total household power, eliminating the hassle for annoying extension cords or power strips. The intuitive control panel includes the VFT Data Center to share real-time updates on maintenance information, making it easy to care for the WH10000DF and ensuring a long life with lasting utility. The hardened-steel frame with added roll bars, foam grip handle, and never-flat wheels lets you easily transport this generator on the go while rubber outlet covers provide added protection from the environment.



**STANDARD FEATURES**

- Ideal for emergency home backup or as a portable power source
- Transfer Switch Ready L14-30R and household GFCI 120V outlets

Part No.	Description	Weight (Dry)
MISWH10000DF	Generator - WGen 10000DF	207 lbs.

# Pressure Washers

**WPX2700** Perfect for deep cleaning home siding, windows, cars, patio furniture and more

The Westinghouse WPX2700 is a 2700psi 2.3 Gal. per minute gas-powered pressure washer with the muscle to blast away grime from even your toughest cleaning jobs. Built from a powerful 4-cycle OHV Westinghouse engine, it's meant for powerful heavy-duty cleaning. From a range of 4 nozzle tips, you can interchange the heads to suit your specific challenge of the day. Constructed with a handy 1.6L soap tank on its side, the WPX2700 is safe to use on brick, stone, concrete, wood, aluminum, and iron. With a 3.3L fuel capacity and never-flat wheels that offer easy roll-away mobility, you can maneuver the strength of this washer to get into hard to reach corners and scale across walls. Deep cleaning projects such as decks, sidewalks, siding, fences, railings, garage floors, exterior walls, cars, and patio furniture is easier than ever before.

- Delivering 2,700 PSI and 2.3 GPM of pressure with a maintenance-free axial cam pump
- Heavy-duty 212cc 4-Cycle Horizontal Shaft Westinghouse Engine with 1 gal. fuel tank
- 4 Quick Connect nozzles: 0°, 25°, 40°, and soap applicator tip for adjustable spray
- Add your own chemical or detergent for extra cleaning power with 0.5 gal. soap tank
- EndraGrasp spray gun with 25 ft. abrasion-resistant hose is lightweight and simple to use
- Rugged steel frame and high profile 12 in. never-flat wheels make maneuverability easy
- CARB compliant with 3-year limited warranty and lifetime technical service
- All Westinghouse pressure washers are functionally tested in the factory and may contain minimum residual oil and/or fuel odor



Part No.	Description	Weight (Dry)
MISWPX2700	Gas Powered Pressure Washer	62 lbs.

## Pressure Washers



### **WPX3200** Heavy Duty Gas Powered Pressure Washer with 5 quick-change nozzle tips!

The Westinghouse WPX3200 3200 psi 2.5 GPM gas powered pressure washer has the muscle to blast away grime from even your toughest cleaning jobs. Built from a powerful 4-cycle OHV Westinghouse engine, its meant for a powerful heavy-duty cleaning. From wide variety of 5 nozzle tips, you can interchange the heads to suit your specific challenge of the day. Constructed with a handy 1.6 l soap tank on its side, the WPX3200 is safe to use on brick, stone, concrete, wood, aluminum and iron. With a 3.3 L fuel capacity and never-flat wheels that offer easy roll-away mobility, you can maneuver the strength of this washer to get into hard to reach corners and scale across walls. Deep cleaning projects such as decks, sidewalks, siding, fences, railings, garage floors, exterior walls, cars and patio furniture is easier than ever before.

- Delivering 3,200 PSI and 2.5 GPM of pressure with a maintenance-free axial cam pump.
- Heavy-duty 212cc 4-Cycle Horizontal Shaft Westinghouse Engine with 1 gal. fuel tank.
- 5 Quick Connect nozzles: 0°, 15°, 25°, 40°, and soap applicator tip for adjustable spray.
- Add your own chemical or detergent for extra cleaning power with 0.5 gallon soap tank.
- EndraGrasp spray gun with 25 ft. abrasion-resistant hose is lightweight and simple to use.
- Rugged steel frame and high profile 12 in. never-flat wheels make maneuverability easy.
- CARB compliant with 3-year limited warranty and lifetime technical service through Westinghouse's support network.
- All Westinghouse pressure washers are functionally tested in the factory and may contain minimum residual oil and/or fuel odor.



Part No.	Description	Weight (Dry)
MISWPX3200	Gas Powered Pressure Washer	63 lbs.

### **WPX3400** Perfect for deep cleaning home siding, windows, cars, patio furniture, and more

The Westinghouse WPX3400 Gas Powered Pressure Washer, with 3400 PSI and 2.6 GPM, is designed to tackle your toughest cleaning jobs with ease. Built with a powerful 4-cycle OHV Westinghouse Engine and a maintenance free axial cam pump, it's meant for powerful heavy-duty cleaning. With 5 interchangeable nozzle tips and a built in 1.6 L soap tank, the WPX3400 has the versatility to handle a variety of situations and surfaces including brick, stone, concrete, wood, aluminum, and iron. The 3.3 L fuel tank and never-flat wheels offer easy mobility and maneuverability, allowing you to get into those hard-to-reach places with the toughest grime. Make all your deep-cleaning projects easier than ever before with the Westinghouse WPX3400 Pressure Washer.

- Delivering 3,400 PSI and 2.6 GPM of pressure with a maintenance-free axial cam pump
- Heavy-duty 212cc 4-Cycle Horizontal Shaft Westinghouse Engine with 1 gal. fuel tank
- 5 Quick Connect nozzles: 0°, 15°, 25°, 40°, and soap applicator tip for adjustable spray
- Add your own chemical or detergent for extra cleaning power with 0.5 gal. soap tank
- EndraGrasp spray gun with 25 ft. abrasion-resistant hose is lightweight and simple to use
- Rugged steel frame and high profile 12 in. never-flat wheels make maneuverability easy
- CARB compliant with 3-year limited warranty and lifetime technical service through Westinghouse's support network.
- All Westinghouse pressure washers are functionally tested in the factory and may contain minimum residual oil and/or fuel odor



Part No.	Description	Weight (Dry)
MISWPX3400	Gas Powered Pressure Washer	63 lbs.

# Cordless Tools



## MIS4LB Cordless 40V Leaf Blower

### STANDARD FEATURES

- Max Air Speed: 90 MPH
- Max Air Volume: 400 CFM
- Jet Fan Design
- TurboBoost Feature
- Battery Type: Lithium-Ion
- Batteries: 2.5 Ah, 4.0 Ah
- Battery and Charger sold separately

Part No.	Description	Weight
MIS4LB	Cordless 40V Leaf Blower	7.9 lbs.



## MIS4HT Cordless 40V Hedge Trimmer

### STANDARD FEATURES

- Cut Capacity: 3/4 in.
- Blade Length: 24 in.
- RPM: 1600
- Strokes Per Min: 3200
- Battery Type: Lithium-Ion
- Batteries: 2.5 Ah, 4.0 Ah
- Battery and Charger sold separately

Part No.	Description	Weight
MIS4HT	Cordless 40V Hedge Trimmer	6 lbs.



## MIS4CSX Cordless 40V Chainsaw

### STANDARD FEATURES

- Bar & Chain: 14"
- Oil Capacity: 200 mL
- Lubrification Type: Auto
- Tool-Free Chain Tensioning
- Battery Type: Lithium-Ion
- Batteries: 2.5 Ah, 4.0 Ah
- Battery and Charger sold separately

Part No.	Description	Weight
MIS4CSX	Cordless 40V Chainsaw	7.9 lbs.



## Cordless Tools



### MIS4PS Cordless 40V Pole Saw

#### STANDARD FEATURES

- Bar & Chain: 8"
- Oil Capacity: 65 mL
- Extension Type: 3 Pole Section
- Full Extension Length: 8.3 ft.
- Battery Type: Lithium-Ion
- Batteries: 2.5 Ah, 4.0 Ah
- Battery and Charger sold separately

Part No.	Description	Weight
MIS4PS	Cordless 40V Pole Saw	8 lbs.



### MIS4ST Cordless 40V String Trimmer & Edger

#### STANDARD FEATURES

- Cut Swath: 13 in.
- Line: Double 8 ft.
- Line Diameter: 0.65"/1.6mm
- Adjustable Swath: 13 to 11in.
- Battery Type: Lithium-Ion
- Batteries: 2.5 Ah, 4.0 Ah
- Battery and Charger sold separately

Part No.	Description	Weight
MIS4ST	Cordless 40V String Trimmer & Edger	6.5 lbs.



### Charger and Batteries



Part No.	Description	Weight
MIS4BC	40V Rapid Battery Charger	1.4 lbs.



Part No.	Description	Weight
MIS4B2AH	2.0 AH Lithium-Ion Battery	2 lbs.
MIS4B25AH	2.5 AH Lithium-Ion Battery	2.5 lbs.
MIS4B4AH	4.0 AH Lithium-Ion Battery	3 lbs.



## WESTWARD PARTS

6517 - 67 St.  
Red Deer, AB T4P 1A3  
Fax: 1-800-661-4508

201 Henderson Dr.  
Regina, SK S4N 7E2  
Fax: 1-800-721-2977

1435 St. James St.  
Winnipeg, MB R3H 0W9  
Fax: 1-800-257-8338

Specifications subject to change without notice or obligation.



WESTWARDPARTS.COM



1-888-937-7278

# FENCING EQUIPMENT

- POST HOLE DIGGERS
- AUGERS & OPTIONS
- HYDRAULIC POST DRIVERS
- SKID STEER POST DRIVERS



**WESTWARD PARTS**

# Post Hole Diggers



## GMR300 Compact/Utility Tractor Post Hole Digger

GMR300 is designed to fit most 14-24 horsepower tractors equipped with a Category 0, 3 point hitch and a 540 rpm PTO. It fits the 16 HP Kubota Model B7100. Capable of handling 6", 9" and 12" diameter standard duty 30" length augers, this 3 position boom allows the unit to fit a variety of tractor models. A lever is provided for the operator to adjust the auger starting angle.

The gearbox has a 3:1 gear ratio and is protected by the shear-pin PTO drive. The gearbox features tapered roller bearings and spring loaded seals and has a 5 year limited warranty. Built for years of trouble-free work with a minimum amount of maintenance.



**NOTE:** Most tractors of this size have lift arms made of 7/8 inch diameter, Category I pins, but with the 20 inch Category 0 spacing. Tractors with very short lift arms made for 5/8 inch diameter pins may not be suitable for digging post holes. (Special 5/8 inch diameter pins are available for those tractors that can handle the post hole digger).



GMR170565



GMR300 Compact/Utility Tractor Post Hole Digger  
(auger not included)

Part No.	Description	Weight (lbs.)
*GMR300	Post Hole Digger	149
GMR170575	6" x 30" Single Flight Post Hole Auger w/teeth	19
GMR170565	9" x 30" Single Flight Post Hole Auger w/teeth	25
GMR170570	12" x 30" Single Flight Post Hole Auger w/teeth	28

\* No auger included



# Post Hole Diggers

**GMR500/720/925** Standard/Heavy Duty/Industrial Post Hole Digger



Part No.	Main Frame	Gear Ratio	Hitch Size	Output Shaft	Driveline Protection	Weight (lbs.)
*GMR500	3" Steel Tube	3.0 to 1.0	Category I/II	2"	Shear Pin	160
*GMR720	3" Steel Tube	3.18 to 1.0	Category I/II	2"	Shear Pin	206
*GMR925	3" Steel Tube	4.1 to 1.0	Category I/II	2"	Shear Pin	210

\* No auger included

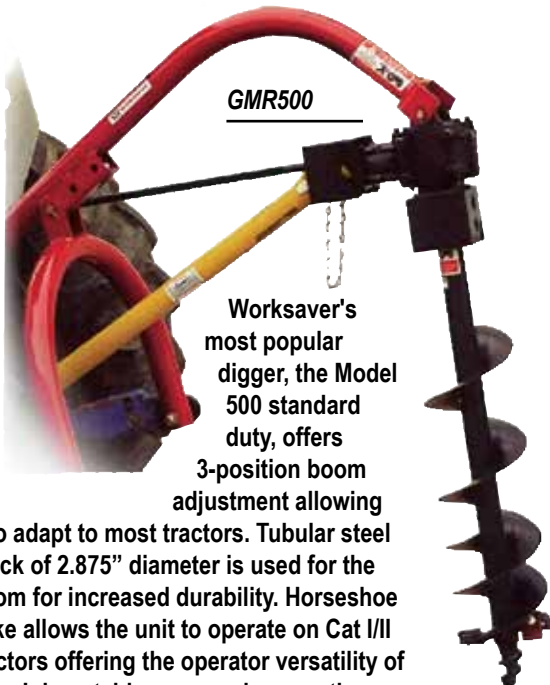

**GMR500**

Worksaver's most popular digger, the Model 500 standard duty, offers 3-position boom adjustment allowing

it to adapt to most tractors. Tubular steel stock of 2.875" diameter is used for the boom for increased durability. Horseshoe yoke allows the unit to operate on Cat I/II tractors offering the operator versatility of use. Job matching augers is easy; they are 42" in length in 6", 9" and 12" diameters in single and double flight configuration. Positioning handle is standard equipment. The gearbox has a limited 5 year warranty and features tapered roller bearings and spring loaded seals.

GMR720 Increased performance is offered in the Model 720 heavy-duty digger. Designed for Cat. I/II tractors, this model offers 3-position boom adjustment, rugged gearbox along with 3-1/2" diameter boom for dependable operation. Augers (42" length) are available in 6", 9", 12", 14", 18" and 24" diameters in single and double flight plus standard or heavy-duty configuration offering the outmost in productivity. The gearbox has a limited 5 year warranty and features tapered roller bearings and spring loaded seals.



GMR925 Industrial duty workhorse, provides dependable operation when mated with any auger from 6" to 30" in diameter. It fits any Cat I/II tractor with 540 rpm PTO. When maximum performance is required, the 4.1:1 ratio gearbox provides the torque to make the operator more productive. The gearbox has a limited 5 year warranty and features tapered roller bearings and spring loaded seals.

OPTIONS / ACCESSORIES		
Part No.	Separate Post Hole Digger Accessories	Weight (lbs.)
GMR170810	Down Force Kit for GMR500 - w/Hyd. Cylinder & Hoses	39
GMR706080	Down Force Kit for GMR720 - w/Hyd. Cylinder & Hoses	40
GMR709025	Down Force Kit for GMR925 - w/Hyd. Cylinder & Hoses	42
GMR102160	Parking Stand Kit for Model GMR300 Post Hole Digger	11
GMR102165	Parking Stand Kit for Models GMR500/720 Post Hole Digger	12
GMR102170	Parking Stand Kit for Model GMR925 Post Hole Digger	13

Down Force Kits provide down force pressure to dig through hard soil surfaces.



GMR709025

# Post Hole Diggers



## Hydraulic Post Hole Diggers *Nine Models to Choose From!*

The models GMR614HC and GMR624HC three point post hole diggers are designed for the operator without a front loader but appreciates the benefits that hydraulic operation offers. Both the GMR614HC and GMR624HC mount to tractors with Category I/II hitches.

The GMR714HC and GMR724HC will attach to backhoe booms or excavators to allow an operator to reach hard to get to places. These units also attach to either side of a loader bucket with four ½" bolts for an unobstructed view of the digging operation.

The GMR814HC models clamp on to the bucket for easy on and off. Each unit slips on to the cutting edge of the bucket and has two turnbuckles and chains to secure it to the bucket. Each unit is adjustable for the left or right side of the bucket, allowing the operator to have a better view of the digging operation.

### FEATURES

- Ability to reverse the auger should it become entangled in roots or rocks.
- No need to replace shear-bolts or repair slip clutches as required on PTO operated units.
- No PTO lifting restrictions with tractor, loader, or backhoe boom.
- All hydraulic units (except GMR614HC and GMR624HC) come less hydraulic hoses.



GMR614HC / GMR624HC



GMR714HC / GMR724HC



GMR814HC

Part No.	Description	Weight (lbs.)
*GMR614HC	3 Point Hydraulic - designed for 5–10 gpm @ 1500–3000 PSI hydraulic systems. (includes hoses) (use 6"–14" augers)	180
*GMR624HC	3 point Hydraulic - designed for 10–20 gpm @ 1,500–3,000 PSI hydraulic systems. (includes hoses) (use 6"–24" augers)	182
*GMR714HC	Loader Hydraulic - designed for 5–10 gpm @ 1500–3000 PSI hydraulic systems. Bolt-on Side Plate (less hoses) (use 6"–14" augers)	125
*GMR724HC	Loader Hydraulic - designed for 10–20 gpm @ 1,500–3,000 PSI hydraulic systems. Bolt-on Side Plate (less hoses) (use 6"–24" augers)	127
*GMR814HC	Loader Bucket Hydraulic designed for 5–10 gpm @ 1500–3000 PSI hydraulic systems. Clamp-on mount (less hoses) (use 6"–14" augers)	194

\* No auger included

# Post Hole Diggers

## Hydraulic Post Hole Diggers *Skid Steer & Euro Global*



Increase your reach over shrubs, fence lines and other obstructions with a skid steer mounted 914HC/924HC hydraulically driven digger. Great time saver with exceptional up-front visibility and control.

### FEATURES

- “Universal” skid steer mount.
- Hydraulically driven.
- For tractor front loaders with “Universal” skid steer mount.
- Handles augers with 2" inside diameter opening.
- No hoses included.
- Hydraulic operation allows user to reverse the auger to clear obstructions.
- Counter weight provides constant balance for true vertical holes.



GMR914HC



GMR924HC

Part No.	Description	Auger Size	Required GPM/PSI	Weight (lbs.)
*GMR914HC	Universal Skid Steer Mount Hydraulic without auger, less hoses	6"- 14"	5-10 GPM @ 1,500-3,000 PSI	208
*GMR924HC	Universal Skid Steer Mount Hydraulic without auger, less hoses	6"- 24"	10-20 GPM @ 1,500-3,000 PSI	210
*GMR924HC/EURO	For tractor loaders with the Euro/Global bucket quick-attach system	6" - 24"	10-20 GPM @ 1,500-3,000 PSI	220

\* No auger included

# Augers & Options

## Post Hole Digger Augers & Options

Part No.	Description	GMR 500	GMR 720	GMR 925	HC Models	Weight (lbs.)
GMR170585	6" Standard Duty Single Flight Auger w/teeth	●	●	●	●	20
GMR706150	6" Heavy Duty Single Flight Auger w/teeth	●	●	●	●	22
GMR706155	6" Heavy Duty Double Flight Auger w/teeth	●	●	●	●	32
GMR170710	9" Standard Duty Single Flight Auger w/teeth	●	●	●	●	28
GMR706109	9" Heavy Duty Single Flight Auger w/teeth	●	●	●	●	37
GMR706009	9" Heavy Duty Double Flight Auger w/teeth	●	●	●	●	47
GMR170720	12" Standard Duty Single Flight Auger w/teeth	●	●	●	●	32
GMR706112	12" Heavy Duty Single Flight Auger w/teeth	●	●	●	●	46
GMR706012	12" HD Double Flight Auger w/teeth	●	●	●	●	54
GMR706033	14" Heavy Duty Single Flight Auger w/teeth	●	●	●	●	62
GMR706037	14" Heavy Duty Double Flight Auger w/teeth	●	●	●	●	76
GMR706070	18" Heavy Duty Double Flight Auger w/teeth	●	●	●	●	98
GMR706075	24" Heavy Duty Double Flight Auger w/teeth	●	●	●	●	128
GMR709045	30" HD Double Flight Auger w/teeth	●	●	●	●	190

All augers are 2" ID round with 42" useable flighting length.



## Augers & Options

### Post Hole Digger Augers & Options



GMR170705



GMR170705



GMP706021

Part No.	Description	GMR 500	GMR 720	GMR 925	HC Models	Weight (lbs.)
GMR170705	12" Auger Extension w/guard	●	●	●	●	16
GMR170430	Bolted Fish Tail Centre Point	●	●	●	●	4
GMP706021	Red Claw Digger Teeth - Heavy Duty Cutting Edge 9-24"					

## Hydraulic Post Drivers

### Manual Adjust, 3 Pt. Hydraulic Post Driver *Handles posts 5" x 9'*

The HPD-16 model with manual adjust quickly delivers a tight post set for wood or steel posts. Base model offers manual adjustment cranks and bubble level for perfect vertical alignment on flatland or hillsides. Transport lock pin secures unit for travel and storage. Greaseable pivot points provide reliable movement of the driver.

Part No.	Description	Weight (lbs.)
GMRHPD16	Manual Adjust, 3 Pt. Hydraulic Post Driver	600

Manual Adjust	GMRHPD16
Max. Post Size	5" x 9'
Impact at Full Stroke	32,000 lbs.
Impact at Half Stroke	16,000 lbs.
Mount Type	3-pt. Cat I/II
Tilt Adj. Front/Back	10° each way
Tilt Adj. Side/Side	17° each way
Manual Adjust	Yes
Stabilizer Legs	Standard
Slide Blocks Material	Nyrim
Spring Post Holder	Standard
Min. Tractor Size	20-22 hp
Rear Hitch Category	Cat. I or II
Min. Hydraulic Req.	3-4 GPM
QuickChange Rod Seal	Yes
Q-springs	N/A
Valve(s)	Sgl. Spool
Hoses less couplers	Standard



# HAY & BALE HANDLING EQUIPMENT

- BALE SPEARS
- BALE CLAMPS
- BALE SPINNERS
- BALE UNROLLERS
- HAY RAKES

## Bale Spears



### Bucket Bolt-on or Clamp-on Bale Spears *Tapered forged bolt-in steel spears.*

#### STANDARD FEATURES

- Quickly convert your front loader bucket into a tool for handling large round bales.
- Each spear mounts on the bucket cutting edge with heavy angle iron for additional support and utilizes the bucket underside for leverage.
- The bolt-on or chain system is used to firmly lock the spear on the bucket.
- Units use tapered “forged” bolt-in steel spears.

*Note: Bale spears are to be inserted into bales.  
Do not use spears as forks.*

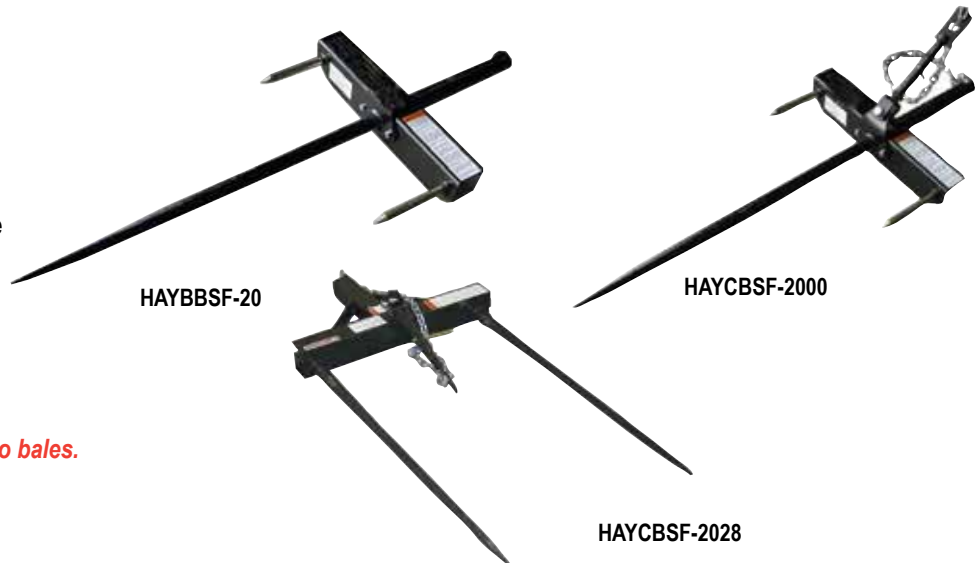

Part No.	Description	Weight
HAYBBSF-20	Bolt-on Bucket Bale Spear for round bales. Rated at 2,000 lbs. Bolt-in spear has useable length of 42". Requires drilling one 17/32" diameter hole in the bucket. Bolt-together design.	65 lbs.
HAYCBSF-2000	Clamp-on Bucket Bale Spear for round bales. Rated at 2,000 lbs. Uses chain and turnbuckle system. Bolt-in spear has useable length of 42". Bolt-together design.	76 lbs.
HAYCBSF-2028	Clamp-on Bucket Bale Spear for round bales. Rated at 3,000 lbs. Uses chain & turnbuckle system. Bolt-in spears have useable length of 42".	102 lbs.

### 3 Point Bale Spears *Designed to mount to Category I, II & III*

#### STANDARD FEATURES

- Designed, depending on model, to handle up to 3,000 lb. bales.
- Features forged spring steel spears designed for hard center bales allowing easier spear penetration of and withdrawal from bale(s).

*Note: Bale spears are to be inserted into bales.  
Do not use spears as forks.*

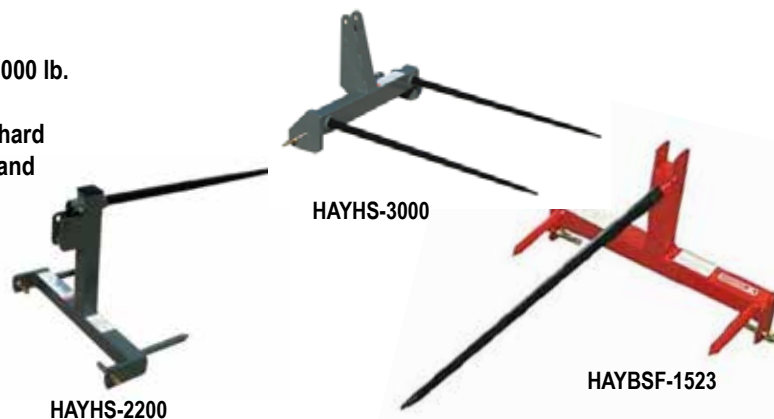

Part No.	Description	Weight
HAYBSF-1523	3-pt. spear for handling round bales up to 1,800 lbs. Tapered main spear has useable length of 44" with two welded balance spears. Fits Cat I/II hitches (shipped with 7/8" pins).	57 lbs.
HAYHS-2200	Rated for round bales up to 2,200 lbs. Bolt-in forged spear with 42" useable length. Two welded balance spears. Cat. I/II Quick Hitch compatible (shipped with 7/8" pins).	72 lbs.
HAYHS-3000	Dual bolt-in forged spears with 42" useable length. Spears are spaced 26" apart allowing bale to be picked up & not lose its orientation. Rated at 3,000 lbs. Fits Cat I/II Quick Hitches (shipped with 7/8" pins).	105 lbs.



# Bale Spears

## Front Loader Bale Spears

**STANDARD FEATURES**

- Designed for use on tractor front loaders or most popular quick-attach front loader systems using our optional interfacing brackets.
- Features an all welded frame, cast steel weld-on spear sockets, and bolt-in spears for increased durability.



HAYFLBS-2200



HAYFLBS-3000

*Note: Do not exceed weight lifting capacity of your loader.*

Part No.	Description	Weight
HAYFLBS-2200	Loader Bale Spear rated at 2,200 lbs. Unit has a tapered spear with a useable length of 42". Designed for use on tractor front loaders. Optional interfacing brackets for most loader quick attach systems are available. (will not accept 831110 brackets). Instead of 831110 brackets, consider SSB-2200.	121 lbs.
HAYFLBS-3000	Loader Bale Spear rated at 3,000 lbs. Unit has Dual tapered spears with a useable length of 42". Designed for use on tractor front loaders. Optional interfacing brackets for most loader quick attach systems are available. (will not accept 831110 brackets). Instead of 831110 brackets, consider SSB-3000.	136 lbs.

## Integrated-Frame Design Bale Spears *Features all welded frame!*

**STANDARD FEATURES**

- All welded frame incorporates interfacing quick-attach brackets for John Deere loaders.
- All models utilize durable bolt-in forged spears.
- All models designed for handling round bales.

*Note: Do not exceed weight lifting capacity of your loader.*

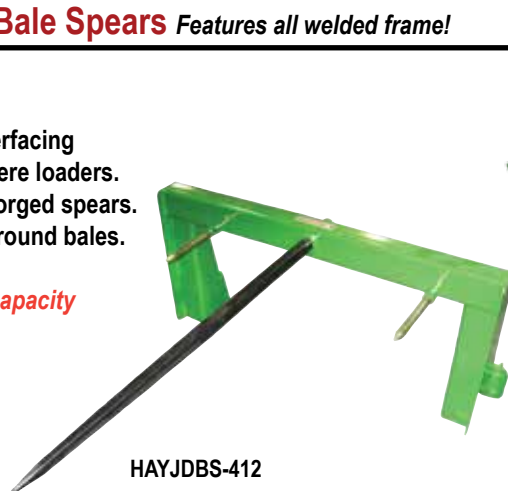

HAYJDBS-412

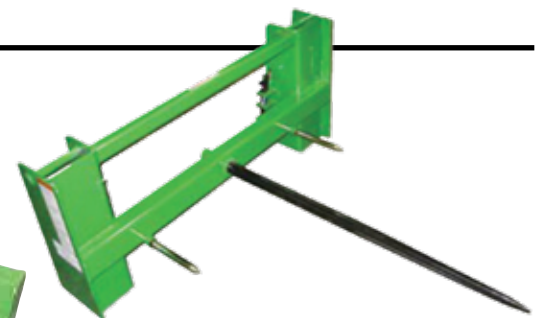

HAYJDBS-612

Integrated-Frame Design for John Deere loader models: 620, 640, 720, 721, 725, 726, 740 and 741		
Part No.	Description	Weight
HAYJDBS-412	Single bolt-in forged spear with useable length of 42". Rated at 2,200 lbs. Two balance spikes, 1" x 8-1/2" useable.	121 lbs.
HAYJDBS-612	Single bolt-in forged spear with useable length of 42". Rated at 2,200 lbs. Two balance spikes, 1" x 8-1/2" useable.	176 lbs.

# Bale Spears



## Euro/Global Integrated Frame Design Bale Spears *With Bolt-in Spears*

### STANDARD FEATURES

- All welded frame design that incorporates the Euro/Global interface.
- Designed to fit tractor loaders with the widely used Euro/Global tool carrier.
- Features bolt-in forged spears for easy penetration of the bale.

*Note: Do not exceed weight lifting capacity of your loader.*

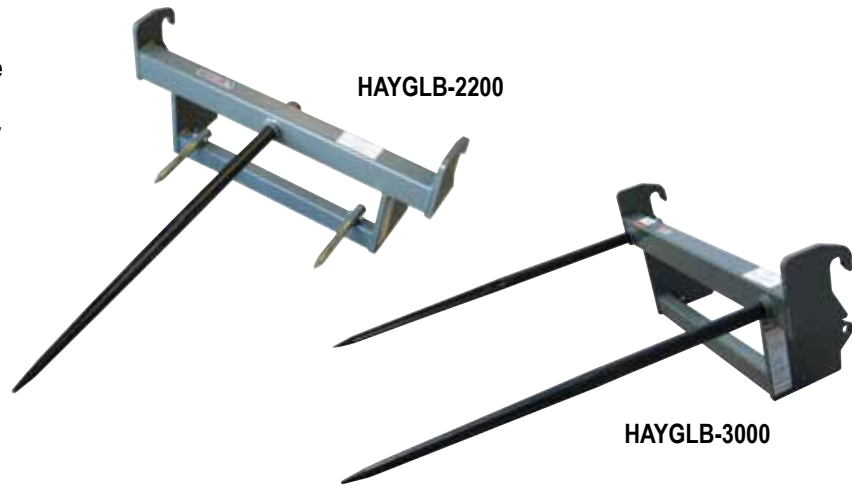

Part No.	Description	Weight
HAYGLB-2200	Single bolt-in forged spear with useable length of 42". Two balance spikes, 1" x 8-1/2" useable. For round bales. Rated at 2,200 lbs.	136 lbs.
HAYGLB-3000	Dual bolt-in forged spears spaced 30" apart, with useable length of 42". For round bales. Rated at 3,000 lbs.	152 lbs.
HAYELB-340	Triple bolt-in forged spears spaced 26" apart, with useable length of 42". For handling single or double large-size square bales. Rated at 4,000 lbs. Optional upright kit (831095) must be used when handling two bales.	200 lbs.



HAYELB-340





# Bale Spears

## Skid Steer Bale Spears

### STANDARD FEATURES

- Designed for front loaders and skid steers using the industry standard “universal quick-attach” system.
- Unique step through design provides easy access to the skid steer.
- Bale spears are offered to handle large round bales as well as mid-size and large rectangular bales.
- Optional uprights allow handling of two rectangular bales at a time.
- All units utilize bolt-in “forged” spring steel tines for easy spear penetration of the bale.



HAYSSB-2200

*Note: Do not exceed weight lifting capacity of your loader.*

Part No.	Description	Weight
HAYSSB-2200	Skid steer single bale spear. Forged bolt-in spear with useable length of 42". Rated at 2,200 lbs.	129 lbs.
HAYSSB-3000	Skid steer dual bale spear. Forged bolt-in spear with useable length of 42". Rated at 3,000 lbs.	146 lbs.
HAYSSRB-330	Skid steer triple bale spear. Forged bolt-in spears spaced 26-1/2" apart, with useable length of 26". For handling single or double (with optional uprights HAY831095) mid-size square bales. Rated at 3,000 lbs.	165 lbs.
HAYSSRB-340	Skid steer triple bale spear. Forged bolt-in spears spaced 26-1/2" apart, with useable length of 42". For handling single or double (with optional uprights HAY831095) large-size square bales. Rated at 4,000 lbs.	190 lbs.



HAYSSB-3000



HAYSSRB-330



HAYSSRB-340

## Replacement Bale Spears



Part No.	Description	Weight
HAYARSP49A	3,500 lb. replacement spear and nut. 49" long	28 lbs.
HAYARSP39A	3,500 lb. replacement spear & nut. 39" long	18 lbs.
HAYARSP32A	3,500 lb. replacement spear & nut. 32" long	16 lbs.
HAYARSP10	4-3/4" sleeve for Westward forged spear (2-3/8" OD x 1-5/8 iD)	-
HAYARSP09	Nut for Westward forged spear	-
HAY830928	2,200 lb. bolt-in replacement spear only. 47" long (42" useable length)	21 lbs.
HAY832217	2,200 lb. bolt-in replacement spear kit. Includes 47" spear, (42" useable length) sleeve and bolt. Weld in sleeve is 2-1/4" O.D. (Sleeve only part # HAY831069)	26 lbs.
HAY830924	2,200 lb. Bolt-in replacement spear only. 33-1/2" long (26-1/2" useable).	12 lbs.
HAY831273	2,200 lbs. Tapered forged Conus II replacement spear with nut. 49" long (44" useable length)	17 lbs.
HAYCBLT47A	47" Cross Bolt Forged Spear	25 lbs.
HAYCBLTSL	Sleeve for CBLT47A	-



# Bale Clamps



## Bale Clamp, UBH-Series *For wrapped (or dry) round bales*

### STANDARD FEATURES

- The “Bale Hand” will gently handle large round wrapped or unwrapped bales with weight up to 2,200 lbs.
- Provides smooth curved clamping arms to prevent wrapped bale puncture.
- This unit fits most double-cylinder front loaders with load arm distance of 54" or less.
- Optional pin-on brackets or interfacing brackets for most popular quick-attach front loaders are available with loader arm distance of 55" or less.



*Note: Do not exceed weight lifting capacity of your loader.*

Part No.	Description	Weight
HAYUBH2072	"Bale Hand" Designed to handle 4' to 6' round bales, wrapped or dry, up to 2,200 lbs. Both arms open to clamp bale. Hydraulic cylinder included.	520 lbs.

# Bale Unroller



## Bale Unroller

Feeding unrolled round bales allows the operator to relocate the feeding area, reducing manure buildup and providing ample space for livestock to “graze” naturally, ensuring that all are fed. Moving, loading, or unloading single stacked round bales from trailers or racks can all be done with this single tool built for multiple bale handling functions.

The HAYBH1 is designed for round bales either 4' or 5' in width and up to 6' in diameter weighing up to 2,000 lbs.

The HAYBH1 mounts on Category I, 3 point hitches. A standard 2" or 2 1/2" x 8" hydraulic cylinder is required (not included) (cylinder with 1" clevis type ends).



### SPECIFICATIONS

- Length: 68"
- Width: 71"
- Height: 27"
- Weight: 310 lbs.
- Minimum point spread: 25"
- Maximum point spread: 76"
- 3 pt. hitch: Standard Category I
- Heavy steel construction.

Part No.	Description	Weight
HAYBH1	3 Pt. Bale Handler/Unroller	285 lbs.
HYD662293	2" x 8" Cylinder	15 lbs.
HYD662305	2 1/2 x 8" Cylinder	21 lbs.

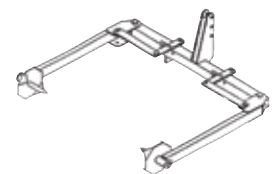

# Bale Spin Off



## 3 Point Bale Spin Off

Designed as an efficient hay management tool for moving and feeding round bales, the RW Spin Off hydraulically rotates the bale, unwinding the hay into a windrow. Rotates in both directions for easy feeding and allows the operator to unroll what the cattle will clean up, eliminating wasted hay. Also, by changing the feeding location each day, the operator can eliminate manure buildup.

Designed to fit Category II or Category III 3-pt hitches and is hydraulically driven for better operator control, providing easy operation from the cab and features a forged tapered spear for easier bale penetration.



**SPECIFICATIONS**

- Length w/Spear: 64 3/4"
- Width: 44 3/4"
- Height: 26 3/4"
- GMP Requirement: 8 - 10 GPM
- PSI Requirement: Min. 1500 PSI

Part No.	Description	Weight
HAYFSO-906	3 pt. spear for handling round bales up to 1,800 lbs. Tapered main spear has useable length of 53" with two welded balance spears. Fits Cat I/II hitches (shipped with 7/8" pins).	250 lbs.

Note: Spears must be inserted into the bale.

# Haysaver 3 Point Hay Rakes



## 3 Pt. Hay Rakes 2 Wheel, 3 Wheel or 4 Wheel models to choose from!

**STANDARD FEATURES**

- Faza Haysaver rakes are built of heavy solid steel tubing.
- Forged steel spoke hubs and conical roller bearings.
- Rake wheels feature tines with a larger gauge than the competition for longer life, while retaining maximum flexibility.
- Rakes take up minimal room in transport mode.
- Ultimate in reliability and performance.

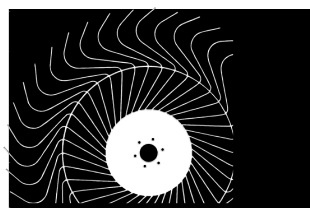
	2 Wheel Rake	3 Wheel Rake	4 Wheel Rake
	HAY3P2	HAY3P3	HAY3P4
Number of Wheels	2	3	4
Number of Teeth Per Wheel	40	40	40
Wheel Diameter	55"	55"	55"
Tooth Diameter	9/32"	9/32"	9/32"
Mounting	3 point	3 point	3 point
Working Width	4'	6'3"	8'6"
Transport Width	4'11"	5'	7'3"
Operating Speed	14 mph	14 mph	14 mph
Minimum HP Required	20	20	30
Weight	187 lbs.	286 lbs.	407 lbs.

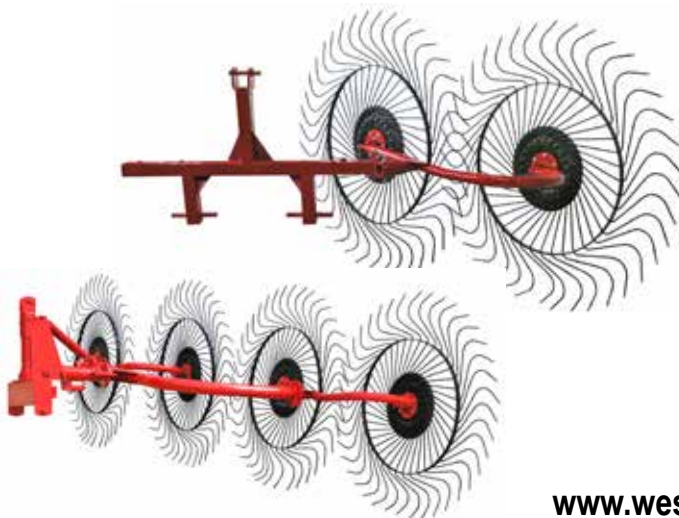

# Haysaver Pull-Type Wheel Rakes

**MODEL HAYCTH8** 8 Wheel Pull Type Rake **HAYCTH10** 10 Wheel Pull Type Rake



**STANDARD FEATURES**

- 8 or 10–55" diameter raking wheels.
- 17'9" or 21' raking width.
- 9'6" transport width.
- 25 to 35 horsepower required.
- Unique cart design offers excellent flotation and ability to follow the contours of the field.
- Hydraulic cylinders and hoses supplied.
- Easily adjustable for different hay conditions and windrow widths.



*Hydraulic cylinders and hoses supplied.*

**EASILY ADJUSTABLE!**

Model	Diameter	Number Raking Wheels	Working Width	Tractor Req.	Weight	Transport Width	Speed	Tires
HAYCTH8	55"	8	17' 9"	25 hp	1,455 lbs.	9'6"	14 mph (22.5 kmh)	195/75-14
HAYCTH10	55"	10	21'	30 hp	1,631 lbs.	9'6"	14 mph (22.5 kmh)	195/75-14

*Hydraulic cylinders enable the closing device ensuring easy transportation.*



# Replacement Tines and Rake Wheels

## Rake Tine OT-1A

### SPECIFICATIONS

- Application Notes: Hesston, Jiffy, OTMA, New H&S, Faza
- Mfr Part #: OT-1A 7MM
- Wire Size: .281"
- Application: Hay Rakes
- Style: Straight
- OEM Part #: 203055, 565050, 700001825
- Type: Single
- Diameter: .281"
- Length: 6.5" x 11.5" x 15"



Part No.	Description	Weight
TINOT-1	Rake Tine OT-1A	0.5 lbs.

## Rake Wheels



Part No.	Description
OTMH001	Rake Wheel (RH) Right Rake
OTMH001L	Rake Wheel (LH) Left Rake

# LAWN & GARDEN/ATV EQUIPMENT

- AERATORS
- CARTS
- SPREADERS
- LAWN ROLLERS
- LAWN SWEEPS
- MOWERS



**WESTWARD PARTS**

# Lawnkeeper



## GMRLK1 Westward Lawnkeeper – Gas Powered

### STANDARD FEATURES

- Turns a rough cut into a smooth finish even under heavy grass conditions.
- Saves time with its unique offset pull hitch - you can mow and sweep at the same time!
- Large capacity of 21 cu. ft.
- More capacity means less unloading time.
- Easy to unload – just lift the hopper door and it automatically locks open to give quick unloading.
- Nothing is permanently mounted to a tractor or mower allowing for greater versatility and easy access to other implements.
- Heavy duty unibody frame.
- 41" sweeping width.
- 4" x 41" replaceable brush sections.
- 3 paddle sweeping brush.
- 2 x 8 x 3 castoring nose wheel.
- Offset and straight pull hitches standard.
- Simple single belt drive.
- Powder coat paint.
- Heavy duty molded hopper.
- 16 x 6.50 x 8 floatation tires.
- Positive sweeping height adjustment.



**Westward Parts Lawnkeeper (LK1) is assembled in Western Canada.**

Part No.	Description	Weight
GMRLK1	Powered Lawn Sweep	250 lbs.

- *High Quality Parts*
- *Affordable price*
- *One year limited warranty*



**Powered by 5 HP Honda Gas Engine.**



**Pneumatic Tires.**



**Long-life nylon brushes to withstand continuous use.**



**Poly molded hopper with 21 Cu. Ft. Capacity.**

Part No.	Description
GMPJ600210	Replacement Brush Strip - each unit requires three.





## Aerators

**Agri-Fab**  
Lawn Care Made Easy

### GMR45-0365 Push Spike Aerator

#### STANDARD FEATURES

- 16" aerator width is easy to maneuver on small lawns.
- 7" aerator disc diameter provides for a 2.5" soil penetration depth.
- Weight tray holds extra weight for increased soil penetration.
- Scratch resistant powder coat paint.
- 5 durable spike discs penetrate the soil easily.
- Assembled product size: 17" x 8." x 38".
- Carton size L x W x H 18.2" x 13.5" x 3.7".

Part No.	Description	Weight
GMR45-0365	Push Spike Aerator	28 lbs.



### GMR45-0299 48" Aerator – Plug

#### STANDARD FEATURES

- 48" weight tray holds up to 175 lbs. for increased soil penetration.
- Eight spools of aerator knives, galvanized for rustproof durability.
- 10" x 4" pneumatic tires allow for smooth transport.
- Simple to use cantilever transport handle for easy raising and lowering.
- Assembled product size: 35" x 60" x 36".
- Carton size L x W x H 51" x 17.2" x 7.3".

Part No.	Description	Weight
GMR45-0299	48" Plug Aerator	94 lbs.



*Aeration will loosen the soil to allow air, water and nutrients to reach your lawn's root system.*

*32 galvanized knives penetrate the soil easily.*



*Agri-Fab® plug aerators aerate up to 3" deep for a healthier lawn.*

*Flat free tire for hassle-free maintenance.*

# Aerators

**Agri-Fab**  
Lawn Care Made Easy

## **GMR45-0518** 40" Plug Aerator

### STANDARD FEATURES

- Unique transport handle for easy raising and lowering of the aerator knives.
- 10" flat free tires for smooth transport.
- 24 galvanized knives to penetrate the soil easily.
- Knives 100% pre assembled, saving valuable time.
- Assembled product size: 50" x 39" x 24".
- Carton size L x W x H 43" x 17.6" x 8.6".

**NEW!**



Part No.	Description	Weight
GMR45-0518	40" Plug Aerator	81 lbs.

# Carts

## **GMR45-0528** Carry-All Cart 200 lbs.

### STANDARD FEATURES

- Durable rustproof poly hopper.
- Steel tube handle for easily moving items.
- Maneuverable 20" rubber wheels for smooth transport.
- Ideal for any job around the house or property.
- Assembled product size: 33" x 36" x 46"
- Carton size L x W x H 37.5" x 27.25" x 19"



Part No.	Description	Weight
GMR45-0528	Carry-All Cart	41 lbs.

## **GMR45-0303** Utility Tow Dump Cart 350 lbs.

### STANDARD FEATURES

- Quick release lever for easy dumping.
- Strong steel bed holds up to 350 lbs.
- Pneumatic tires let you go anywhere.
- Removable tailgate for easy unloading.
- Assembled product size: 60" x 33" x 28"
- Carton size L x W x H 42.0" x 17.3" x 14.0"



Part No.	Description	Weight
GMR45-0303	Utility Tow Dump Cart	68 lbs.

## Carts

**Agri-Fab**  
Lawn Care Made Easy

### **GMR45-0552** Poly Cart 700 lbs.

#### STANDARD FEATURES

- 700 lbs. load capacity for large loads.
- 3" x 1.5" heavy gauge channel tongue.
- Ergonomic Heavy duty latch system to easily dump the bed contents.
- 110 degree swivel feature and 52° dump angle.
- 15" x 6" pneumatic Turf tread tires with powder metal bearings allow for easy maneuverability over the roughest terrain.
- Heavy duty welded frame features 1" square tubing and has a 12" ground clearance.
- Assembled Product 73" x 37" x 27.5"
- Carton size L x W x H 49.12" x 34.12" x 11.87"

Part No.	Description	Weight
GMR45-0552	Poly Cart	57 lbs.



### **GMR45-0553** Poly Cart 1,000 lbs.

#### STANDARD FEATURES

- 1000 lbs. load capacity for large loads.
- 3" x 1.5" channel tongue.
- Ergonomic Heavy duty latch system to easily dump the bed contents.
- 110 degree swivel feature and 52° dump angle.
- 16" x 6.5" Turf tread pneumatic tires with powder metal bearings allow for easy maneuverability over the roughest terrain.
- Heavy duty welded frame features 1" square tubing and has a 12" ground clearance.
- Assembled Product 80" x 40.75" x 30.5"
- Carton size L x W x H 60" x 39.5" x 17"

Part No.	Description	Weight
GMR45-0553	Poly Cart 1,000 lbs.	85 lbs.



# Carts



**GMR45-0101-999** Utility Tow Dump Cart 750 lbs.

**STANDARD FEATURES**

- Steel bed with scratch-resistant, powder-coat paint finish for longer product life.
- 750 lbs. load capacity for the large loads.
- 16" x 4" pneumatic tires allow for easy maneuverability over rough terrain.
- Assembled product size: 70.0" x 33.0" x 29.0"
- Carton size L x W x H 48.0" x 19.0" x 13.5"



Part No.	Description	Weight
GMR45-0101-999	Utility Tow Dump Cart	102 lbs.

**GMR45-0529** Poly Cart (ATV/UTV) 1,000 lbs.

**STANDARD FEATURES**

- Unique design allows for increased ground clearance to go anywhere.
- Pneumatic tires let you go anywhere.
- Swivels up to 100° to allow for easy dumping.
- Assembled product size: 80.0" x 53.0" x 30.0"
- Carton size L x W x H 59.0" x 39.3" x 15.5"
- Bed Size: 38" x 56" x 14"
- Bed Capacity (Heaped): 17 Cu. Ft.



Part No.	Description	Weight
GMR45-0529	Poly Cart (ATV/UTV)	137 lbs.

## Carts

**Agri-Fab**  
Lawn Care Made Easy

### **GMR45-0555** Poly Cart 1,200 lbs.

#### STANDARD FEATURES

- Utility 10, Bed dimensions: 45" x 31" x 10.75"
- Robust 1.25" square tubed & channel frame.
- 1200 lbs tow capacity.
- Tow or pull option.
- 13" x 4" Knobby tread tires.
- 62° dump angle allow for complete debris clearing from bed.
- Assembled Product 70" x 36" x 24"
- Carton size L x W x H 45.2" x 35.4" x 11.4"

Part No.	Description	Weight
GMR45-0555	Poly Cart 1,200 lbs.	68 lbs.



**NEW!**



#### Easy as 1...2...3

- Switching between pull & tow.

### **GMR45-0554** ATV/UTV Steel Cart 1,500 lbs.

#### STANDARD FEATURES

- Bed Size: 60" x 32" x 24"
- 1500 lbs. load capacity for heavy loads
- 18" x 9.5" all terrain pneumatic tires with roller bears allow for easy maneuverability over the roughest terrain.
- 110 degree swivel feature and 60° dump angle.
- Heavy Duty 1" square tubed welded frame.
- 12" Ground clearance.
- Quick Easy removable sides allow for flatbed use.
- Assembled Product 82" x 50" x 43"

Part No.	Description	Weight
GMR45-0554	Poly Cart 1,500 lbs.	205 lbs.



**NEW!**



#### 110° swivel feature

- Dump lawn debris where you want it



#### Maneuverable

- Pneumatic tires let you go anywhere.

# Tine Dethatcher



**GMR45-0294** 40" Tine De-thatcher

**GMR45-0295** 48" Tine De-thatcher

**STANDARD FEATURES**

- 20 or 24 heat-treated spring tines for durability.
- 40" or 48" tray holds up to 70 lbs. for improved thatch removal.
- 7" x 1.5" semi-pneumatic tires allow for smooth transport.
- Simple-to-use cantilever transport handle for easy raising and lowering.

Part No.	Description	Weight
GMR45-0294	40" Tine Dethatcher	30 lbs.
GMR45-0295	48" Tine Dethatcher	37 lbs.

Replacement Tine  
GMP43783

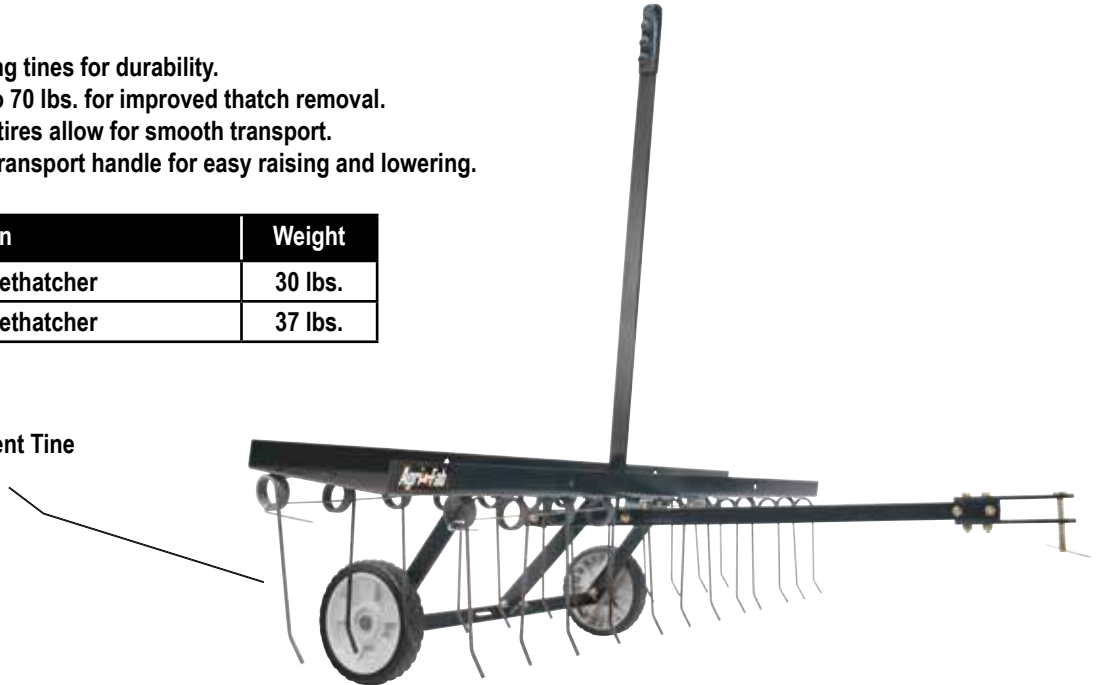

**GMR45-0343** Universal Front Mount De-thatcher

**STANDARD FEATURES**

- Dethatcher for 30", 38", 42", and 46" Lawn Sweepers
- Easily attaches to most popular lawn sweeper brands.
- Scratch resistant powder coat paint.
- 14 heat-treated spring tines remove thatch quickly.
- Scar-free wheel rolls easily.

Part No.	Description	Weight
GMR45-0343	Universal Front Mount De-thatcher	12 lbs.



## Discs



### **GMRFOD-15** Flip-Over Single Gang Disc for ATV's

#### STANDARD FEATURES

- Ideal pull type implement for garden tractors and ATV's.
- Great for tilling gardens, orchards or field game plots.
- Eight 16" notched disc blades.
- Transport wheels 4" x 12" pneumatic.
- Disc gangs are at 20° angle for optimum cutting.
- Rear tab for drag harrow attachment.
- Minimum horsepower 16 HP or 350cc.
- Axle 1" square.
- Cast iron bearings with grease zerks.
- Overall width 53".
- Overall height 35".
- Overall length 70" (w/tongue).



Part No.	Description	Weight
GMRFOD-15	5' Disc Complete	240 lbs.

*Flip-over disc incorporates a square weight frame in its design which allows the operator to strap 3 concrete blocks to the top of the disc, increasing its weight for more aggressive soil penetration.*

## Tiller



### **GMR45-0308** Multi-Fit Tow-Behind Tiller

#### STANDARD FEATURES

- Briggs & Stratton® Intek Series™ 875 engine (206cc/gross torque rating 8.75).
- Forward-rotating tines prepare seedbeds quickly.
- Six, double-edge, 11" diameter heavy-duty tines make short work of your tilling needs.
- Tine adjustment from 1½–5½".
- Hitch pin attachment allows for easy fit-ups to vehicles without any additional equipment required.
- Metal parts are powder-coated for lasting corrosion resistance.
- 56" x 38" x 32" assembled.



Part No.	Description	Weight
GMR45-0308	Multi-Fit Tow-Behind Tiller	257 lbs.





# Lawn Rollers

## **GMR45-0267** 250 lbs. Poly Push/Tow Roller

### STANDARD FEATURES

- 18" diameter x 24" wide.
- Poly construction for rustproof durability.
- Drum capacity 250 lbs. (water).
- Lightweight when empty, for easy transport and storage.
- 50" x 30" x 18" assembled.



Part No.	Description	Weight
GMR45-0267	Poly/Push Tow Roller	40 lbs.

## **GMR45-0268** 400 lbs. Poly Tow Roller

## **GMR45-0269** 550 lbs. Poly Tow Roller

### STANDARD FEATURES

- 18" diameter x 36" wide.
- Poly construction for rustproof durability.
- Drum capacity 400 lbs. (water).
- Spoke-wheel insert adds strength and durability.
- Lightweight when empty, for easy transport and storage.
- 50" x 42" x 18" assembled.



Also available GMR45-0269

- 18" x 48" Poly Tow Roller with 550 lbs. (water) capacity.
- 54" x 54" x 18" assembled.



Part No.	Description	Weight
GMR45-0268	36" Poly Tow Roller	45 lbs.
GMR45-0269	48" Poly Tow Roller	58 lbs.

## **GMR45-0179** 640 lbs. Commercial Steel Tow Roller

### STANDARD FEATURES

- Up to 640 lbs. water capacity.
- 24" diameter x 36" wide roller drum.
- Welded seam steel construction for strength and durability.
- Heavy-duty hitch tubes and scraper bar for reliable operation.
- 40" x 51" x 24" assembled.



Part No.	Description	Weight
GMR45-0179	36" Wide Steel Tow Roller	93 lbs.

## Lawn Rollers

**Agri-Fab**  
Lawn Care Made Easy

### **GMR45-0216** 910 lbs. Wide Steel Tow Roller

#### STANDARD FEATURES

- Up to 910 lbs. water capacity.
- 24" diameter x 48" wide.
- Welded seam steel construction for strength and durability.
- Heavy-duty hitch tubes and scraper bar for reliable operation.
- 52" x 51" x 24" assembled.



Part No.	Description	Weight
GMR45-0216	48" Wide Steel Tow Roller	114 lbs.

### **GMR45-0549** 1150 lbs. Steel Tow Roller

#### STANDARD FEATURES

- Up to 1150 lbs. capacity.
- 24" diameter x 60" wide.
- Hitch tubes act as a scraper bar to prevent clumps of soil from being compacted on the roller drum.
- Roller drain/fill plug empties easily and fills with a regular garden hose.
- 67" x 44" x 24" assembled.



Part No.	Description	Weight
GMR45-0549	24" x 60" Steel Tow Roller	137 lbs.

## Leaf Blade

**Agri-Fab**  
Lawn Care Made Easy

### **GMR45-0550** Leaf Blade

#### STANDARD FEATURES

- Designed for ZT tractors.
- Nearly 60" width.
- Small storage footprint – takes up less space in your garage.
- Innovative mounting bracket requires no additional kits.
- Durable 14 gauge construction.
- Quickly and efficiently move leaves.
- Fits most popular ZT in the market.
- Assembled Product 42.1" x 59.68" x 42.2"

Part No.	Description	Weight
GMR45-0550	Leaf Blade	60 lbs.



# Smart Series



Introducing the Smart Series, exclusively from Agri-Fab®, the smartest ideas to hit the lawn care industry in years.

With revolutionary new designs, innovative new features and the quality you only get from Agri-Fab®, these are the kinds of tools and attachments that can completely change the game. Based on consumer research and, of course, Agri-Fab's decades of experience, these products do things differently; they do things better. And they'll keep doing them "Season After Season™".



- SmartLINK™ attachments are convenient to use, and can be easily stored – smart!
- Switch from one lawn implement to another in seconds without tools.
- Master Platform necessary for all attachments.



SmartLINK™ system patented locking device enables attachments to lock in and unlock in seconds.

**GMR45-0473** SmartLINK™ Master Platform Patent 7,604,066

**STANDARD FEATURES**

- Durable steel deck and universal hitch.
- Easily attach all SmartLINK™ accessories.
- Easy, stand up storage capability.
- Accepts all SmartLINK™ attachments easily.
- Assembled product size: 55" x 53" x 19".
- Carton size L x W x H 49.8" x 20.3" x 9.1".

Part No.	Description	Weight
GMR45-0473	SmartLINK Master Platform	62 lbs.



## Smart Series

**Agri-Fab**  
Lawn Care Made Easy

### **GMR45-0474 SmartLINK™ Plug Aerator** Patent 7,604,066

#### STANDARD FEATURES

- Attaches to the SmartLINK™ Master platform in seconds without tools.
- Rustproof aerator knives for strength and durability.
- Allows air, water and nutrients to reach soil.

Part No.	Description	Weight
GMR45-0474	SmartLINK™ Plug Aerator	29 lbs.

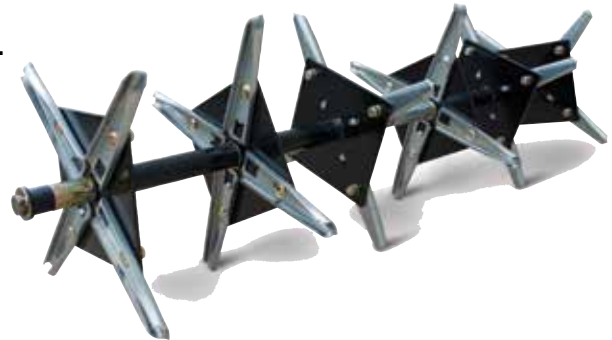

### **GMR45-0457 SmartLINK™ Tine Dethatcher** Patent 7,604,066 & 7,073,317

#### STANDARD FEATURES

- Attaches to the SmartLINK™ Master Platform in seconds without tools.
- Effectively removes thatch buildup for a healthier lawn.
- 20 heat-treated spring tines for durability.

Part No.	Description	Weight
GMR45-0457	SmartLINK™ Tine Dethatcher	19 lbs.

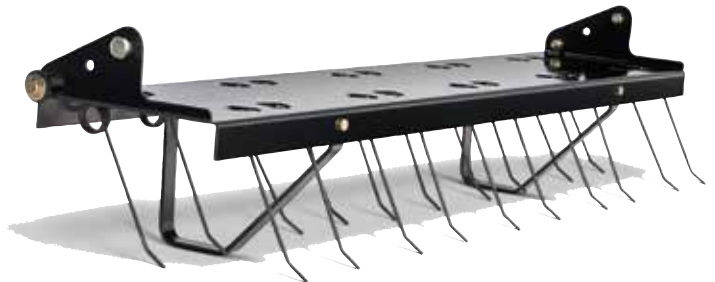

### **GMR45-0458 SmartLINK™ Spike Aerator** Patent 7,604,066

#### STANDARD FEATURES

- Excellent for use in lightly compacted soil.
- Easily attaches to SmartLINK™ master platform without tools.
- 10 durable spike discs penetrate the soil easily.

Part No.	Description	Weight
GMR45-0458	Turf Shark™ Spike Aerator	22 lbs.





# Lawn Sweepers

## GMR45-0218 26" Push Lawn Sweeper

### STANDARD FEATURES

- Sweeper width — 26".
- Durable poly housing resists rust.
- Lightweight design allows for easy pushing.
- Conveniently collapsible hopper for easy storage.
- 52.5" x 31" x 33" assembled.

Part No.	Description	Weight
GMR45-0218	Push Lawn Sweeper	26 lbs.



## GMR45-0570 30" Push Lawn Sweeper

### STANDARD FEATURES

- 12 cu.ft. Hopper Capacity
- Innovative forward dump feature, remove debris with less effort
- 16 gauge Steel Frame, doesn't twist when pushing
- 10" x 1.5" Flat Free tire
- 30 inch working width
- (4) – 10 inch diameter brushes
- Infinite brush height adjustment
- Adjustable handle height for optimum comfort and control with less effort
- Bag-in-Bag feature increase your capacity
- Quick and easy assembly, bag assembles without tools
- Assembled Product 47.58" x 36.73" x 38.23"



Part No.	Description	Weight
GMR45-0570	30" Push Lawn Sweeper	48 lbs.



## GMR45-0320 42" Tow Lawn Sweeper

### STANDARD FEATURES

- Sweeper width — 42" — most popular!
- Unique design provides more traction on the sweeper wheels for greater debris pickup.
- Stamped steel housing provides durability to withstand season after season of use.
- Easy height adjustment and strong brushes.
- Easy Pin Attachment.
- 67" x 51" x 24" assembled.
- Carton size L x W x H - 51.5" x 14" x 13".

Part No.	Description	Weight
GMR45-0320	42" Tow Lawn Sweeper	68 lbs.



Universal hitch fits many different lawn and garden tractors.



1-888-937-7278

# Lawn Sweepers



**GMR45-0492** 44' SmartSWEEP™ Patent Pending

**STANDARD FEATURES**

- No-skip design cleans up debris in one pass.
- Extra-large lawn debris bag 25 cu. ft. reduces time between emptying.
- Cut and sweep the lawn at the same time.
- Collapses for easy, compact storage.
- Easy dumping design eliminates need to get off the tractor to dump debris.
- Unique design allows for easy bag removal.
- Features one-button brush height adjustment.
- Modern styling with sleek metal housing.



Part No.	Description	Weight
GMR45-0492	44" Lawn Sweep	85 lbs.

**GMR45-0546** 52" Tow Lawn Sweeper

**STANDARD FEATURES**

- Extra-large flow through bag so you don't have to stop as often.
- Remove and fold bag without tools for easy storage.
- Easily and quickly attaches to all tractors.
- 70.0" x 60.0" x 38.0" assembled.
- Carton size L x W x H - 61.3" x 17.8" x 13.8".



Part No.	Description	Weight
GMR45-0546	52" Tow Lawn Sweeper	95 lbs.

**Replacement Parts** Replacement Brushes

Part No.	Description
GMP48557	Replacement Brush for GMR45-0320 - Brush 42" Sweeper
GMP46780	Replacement Brush for GMR45-0492 - Brush 42" Sweeper
GMP45252	Replacement Brush for GMR45-0546 - Brush 52" Sweeper



# Vacs



## **GMR55188** *Hard Top Mow-N-Vac®*

### STANDARD FEATURES

- Large 32 cubic foot capacity.
- Durable vented hard top design reduces airborne dust.
- Easily lift, attach, or move using the handle.
- Foot lever release for easy empty.
- 96" x 33" x 62" assembled.

Part No.	Description	Weight
GMR55188	Hard Top Mow-N-Vac®	335 lbs.



## **GMR45-0540** *Hard Top Chip-N-Vac®*

### STANDARD FEATURES

- Large 32 cubic foot capacity.
- Durable vented hard top design reduces airborne dust.
- Easily lift, attach, or move using the handle.
- Foot lever release for easy empty.
- Turns tree branches up to 2" in diameter into mulch.
- 96" x 33" x 62" assembled.

Part No.	Description	Weight
GMR45-0540	Hard Top Chip-N-Vac®	370 lbs.



## **GMR45-0567** *Soft Top Lawn Vaccum*

### STANDARD FEATURES

- Briggs & Stratton 163 cc Engine.
- 29 cu.ft . Capacity / 220 gallons.
- Utility 10 cu.ft . Poly Bed.
- Build in boot on top with drawstring...Eliminates wear point!
- 13" x 4" pneumatic tires.
- Thick vinyl top with Ripstop nylon woven in to strengthen the top and prevent tears. Venting through back limits dust and debris.
- Easy to dump with foot pedal dumping operation, and fold up vinyl top.
- Universal deck adapter and 126" x 6" clear hose fits right hand discharge decks , hose length appropriate for zero turns.
- Easy Top Assembly.

Part No.	Description	Weight
GMR45-0567	Soft Top Lawn Vaccuum	22 lbs.



## **GMR45-0253** *Hose Kit*

### STANDARD FEATURES

- Fits Agri-Fab's® Vac-N-Go™, Mow-N-Vac™ and Chip-N-Vac™

Part No.	Description	Weight
GMR45-0253	Hose Kit	22 lbs.



## Economy Cutter

### Tebben Light Duty Cutter 40" Economy Cutter



#### STANDARD FEATURES

- 40 HP Rated Gear Box.
- Stump jumper pan.
- Laminated tail wheel.
- Cat. 4 Driveline.
- Cat. 1 Three point hitch.
- 540 RPM PTO.



Part No.	Description	Weight
GMRTC07-40	40" Economy Cutter	400 lbs.

## Round Back Cutters

### Tebben Roundback Rotary Cutter 3 Pt. Rear Discharge

#### STANDARD FEATURES

- 20" diameter stump jumper.
- 1/2" x 3" forged, heat treated blades.
- 16" diameter solid rubber tail wheel.
- 10 gauge formed deck.
- 40 HP Gear Box.
- Category 4 driveline.
- Category 1 or 2 Three point hitch.
- 540 RPM PTO.
- Optional clutch available for some models.



#### Chain Guard Options

Part No.	Description
GMRTC10-4RC	4' round back rear chain guard
GMRTC10-5RC	5' round back rear chain guard
GMRTC10-6RC	6' round back rear chain guard

Part No.	Description	Minimum HP	3 Pt. Cat.	Weight
GMRTC10-400R	48" Round Back Rotary Cutter	40	Cat 1	445 lbs.
GMRTC10-500R	60" Round Back Rotary Cutter	40	Cat 1	590 lbs.
GMRTC10-600R	72" Round Back Rotary Cutter	40	Cat 1	640 lbs.



# Heavy Duty Cutters



## Tebben Roundback Rotary Cutter 3 Pt. Rear Discharge

### STANDARD FEATURES

- Heavy duty cutters available in 5, 6, and 7, sizes.
- 75 HP Gear Box.
- Laminated Tail Wheel.
- Cat 5 PTO Slip clutch/540 RPM.
- Heavy duty construction for added durability.
- Dual rear tail wheels standard on 7' model only.



Part No.	Description	Weight
GMRTC16-500MC	60" Red Heavy Duty Cutter	685 lbs.
GMRTC16-600MC	72" Red Heavy Duty Cutter	725 lbs.
GMRTC16-700MC	84" Red Heavy Duty Cutter	1000 lbs.

# Heavy Duty Double Cutters

## Tebben 3 Pt Double Cutter

### STANDARD FEATURES

- 3 point mounted cutter with dual pivoting rear tail wheels (laminated).
- Greaseable spindle and hub assembly.
- 120 HP center gearbox & 90 HP outer Gear Box.
- 10 guage top deck, 3/16" & 1/4" welded sides and deck supports.
- 3 Pt. Triple Gear Box.
- Pull type hitch Option available - shown below.



Part No.	Description	Minimum HP	3 Pt. Cat.	Weight
GMRTC96-1000MC	120" Cutter H.D. Double Spindle	120 HP w/ slip clutch	Cat II	1520 lbs.



# Variable Offset Rotary Cutters



**Tebben Offset Rotary Cutter** Available in 7' and 8' models

**STANDARD FEATURES**

- Heavy duty construction.
- Heavy duty triple Gear Box system.
- Cat. 5 PTO/Slip Clutch.
- Hydraulic variable hitch allows you to offset machine Up To 14".
- Can be semi mount or 3PT Mounted.
- Front and rear chain guards optional.



Chain Guard Options	
Part No.	Description
GMRTC94-40FC	40" front chain guard
GMRTC94-40RC	40" rear chain guard
GMRTC94-4FC	4' front chain guard
GMRTC94-5FC	5' front chain guard
GMRTC94-6FC	6' front chain guard

Part No.	Description	Weight
GMRTC94-700	Base 7' Variable Offset Rotary Cutter	1625 lbs.
GMRTC94-800	Base 8' Variable Offset Rotary Cutter	1740 lbs.

# Skid Steer Mounted Cutters

**Tebben Skid Steer Mounted Cutter** Available in 5' and 6' models

**STANDARD FEATURES**

- Heavy Duty Hydraulic Skid Cutter mulches trees and brush up to 3" Diameter.
- Skid Mount Pivots for uneven working conditions.
- Front & Rear chain guards standard.
- Stump jumper PAN/1/2 X 3 Swinging Blades.
- Requires Min 15-20 GPM.



Wheel Kit		
Part No.	Description	Weight
GMRTC10-WA	Optional Wheel Kit for Skid Steer Mowers	115 lbs.

Part No.	Description	Weight
GMRTC10-500-SM	60" Skid Steer Mounted Rotary Cutter - Requires 15-20 gpm, c/w front & rear chain guards	745 lbs.
GMRTC10-600-SM	72" Skid Steer Mounted Rotary Cutter - Requires 15-20 gpm, c/w front & rear chain guards	935 lbs.

# Heavy Duty Finishing Mowers



## Tebben Finishing Mowers 3 Pt. Rear Discharge

### STANDARD FEATURES

- Close mowing.
- High volume operation.
- Rear Clipping Discharge.
- Wide discharge throat.
- 3 Hi-Lift cutting blades.
- Front scuff bar.
- Floating 3-pt. rear hitch.
- Solid wheels and tires and easy height adjustment.
- High blade tip speed.
- Greaseable blade spindle.
- Quick coupler PTO.
- Cast iron gearbox.
- Optional Quick Attach Flexible 3 Pt System.
- Cutting Height: 1-1/2" Minimum to 5-1/4" Maximum.
- Gauge Wheels: 9 x 3.5 - 4.75/2.25, 260 lbs. Load Cap.
- Economical to operate and Easy Maintenance.



Part No.	Description	Minimum HP	3 Pt. Cat.	Overall Width	Blade Tip Speed (FPM)	Blade Size	Weight
GMRTFM19-600	60" 3 Pt. Finishing Mower	25	Cat. 1	64"	21,500	21" Highlift	550 lbs.
GMRTFM19-720	72" 3 Pt. Finishing Mower	35	Cat. 1	76"	21,500	25" Highlift	600 lbs.
GMRTFM19-840	84" 3 Pt. Finishing Mower	40	Cat. 1	88"	21,500	30" Highlift	700 lbs.

## Spreaders

**Agri-Fab**  
Lawn Care Made Easy

### **GMR45-0282** 1 lbs. Hand-Held Spreader

#### STANDARD FEATURES

- Great for small lawns and hard-to-reach areas.
- 1-gallon (dry)/1 lbs. poly cup and hand reel for complete control.
- No assembly required
- 2 lbs. weight.
- 10" x 9" x 9" assembled.



**Precise**  
Control device spreads just the right amount.



**Easy to Operate**  
Just fill and turn the knob to spread.



Part No.	Description	Weight
GMR45-0282	Hand-Held Spreader	2 lbs.

### **GMR45-04091** 50 lbs. Broadcast Spreader

#### STANDARD FEATURES

- 4 gallon (dry) 50 lbs. hopper holds plenty of seed for smaller jobs.
- Up to 8' broadcast coverage lets you get the job done in fewer passes.
- Durable poly wheels.
- 8 lbs. weight.
- 31.9" x 17" x 34" assembled.

Part No.	Description	Weight
GMR45-04091	4-Gallon (dry) Push Broadcast Spreader	8 lbs.



### **GMR45-0566** 50 lbs. Rust-Proof Poly Hopper Spreader

#### STANDARD FEATURES

- Tool less assembly.
- 10" Flat Free tire.
- Build in side deflector.
- Optional Accessories available, grate and cover.
- Enclosed gear box with bevel gears for longer life and smoother rolling.
- Durable cable control with large handle for easy use with gloves.
- Fold up kickstand allows to hang on wall for easy storage.
- Steel "U" shaped handle.

Part No.	Description	Weight
GMR45-0566	50lbs. Rust-Proof Poly Hopper Spreader	7.5 lbs.





# Spreaders

## **GMR45-0563** 70 lbs. Commercial Push Spreader

### STANDARD FEATURES

- Stainless Steel Axle, and spreader shaft.
- Adjustable Handle for any height operator.
- Handle is stow-able for smaller storage footprint.
- Long-Life/No Maintenance UHMW inserted bearing requires limited product maintenance allowing for more up time for commercial operators.
- Zero Flat Spot Hopper Allows for complete emptying of hopper...No bouncing to unit to empty hopper.
- Posi-Loc settings, direct rod control allow for more precise spreader plate settings.
- Auger style agitator allows for better material flow.
- HDPE Deflector narrows spread width.
- 13"x 5" pneumatic tires.
- Enclosed gearbox with beveled heat treated steel gears.



Part No.	Description	Weight
GMR45-0563	70 lbs. Commercial Push Spreader	39 lbs.

## **GMR45-0564** 100 lbs. Commercial Push Spreader

### STANDARD FEATURES

- Stainless Steel frame, handles, axle, and spreader shaft.
- Adjustable Handle for any height operator.
- Handle is stow-able for smaller storage footprint.
- Long-Life/No Maintenance UHMW inserted bearing requires limited product maintenance allowing for more up time for commercial operators.
- Zero Flat Spot Hopper Allows for complete emptying of hopper.
- Posi-Loc settings, direct rod control allow for more precise spreader plate settings.
- Auger style agitator allows for better material flow.
- HDPE Deflector narrows spread width.
- 13"x 5" pneumatic tires.
- Enclosed gearbox with beveled heat treated steel gears.



Part No.	Description	Weight
GMR45-0564	100 lbs. Commercial Push Spreader	43 lbs.

Auger style agitator allows for better material flow.



Optional Grate



Adjustable Handle for any height operator.



## Spreaders

**Agri-Fab**  
Lawn Care Made Easy

### **GMR45-0388** 85 lbs. Push Broadcast Spreader

#### STANDARD FEATURES

- Hopper capacity 7 gallon (dry)/85 lbs.
- Rustproof poly hopper and spreader plate increase product life.
- Up to 10' spread width for reliable coverage.
- Pneumatic tires allow for increased maneuverability.
- 35" x 22" x 33" assembled.

Part No.	Description	Weight
GMR45-0388	7-Gallon (Dry) Push Broadcast Spreader	20 lbs.
GMP40883	Optional Hopper Cover	



### **GMR45-0530** 85 lbs. Tow Spreader

#### STANDARD FEATURES

- 85 lbs. capacity covers about 1/4 acre (14,000 sq. ft.).\*
- Rust-proof poly hopper for long product life.
- Pneumatic tires allow for increased maneuverability.
- 33.0" x 22.0" x 25.0" assembled.

\*Depending on material used and speed of application.

Part No.	Description	Weight
GMR45-0530	85 lbs. Tow Spreader	18 lbs.





# Spreaders

## GMR45-0532 85 lbs. Pro Push Spreader

### STANDARD FEATURES

- 85 lbs. capacity covers about 1/4 acre (14,000 sq. ft.)\*
- Rust-proof poly hopper for long product life.
- Enclosed gearbox.
- Direct rod control.
- 20.0" x 22.5" x 27.5" assembled.

\*Depending on material used and speed of application.

Part No.	Description	Weight
GMR45-0532	85 lbs. Pro Push Spreader	22 lbs.



## GMR45-0527 110 lbs. Tow Spreader

### STANDARD FEATURES

- 110 lbs. capacity covers about 1/3 acre (17,500 sq. ft.)\*
- Rust-proof poly hopper for long product life.
- Durable steel gear and pinion
- Up to 10' spread width for reliable coverage.
- Pneumatic tires allow for smooth transport.
- 41.0" x 26.0" x 25.0" assembled.

\*Depending on material used and speed of application.

Part No.	Description	Weight
GMR45-0527	110 lbs. Tow Spreader	31 lbs.



## Spreaders

**Agri-Fab**  
Lawn Care Made Easy

### **GMR45-0462** 130 lbs. SmartSPREADER™ Push Broadcast

#### STANDARD FEATURES

- Extra large 130 lbs. hopper capacity to finish projects faster.
- Professional-style, easy-set controls for precise application.
- Enclosed commercial-grade gearbox for smooth rolling and easy maintenance.
- Large pneumatic tires for easy maneuverability.
- Fast and easy assembly.

Part No.	Description	Weight
GMR45-0462	Push Broadcast Spreader	37 lbs.



### **GMR45-0463** 130 lbs. SmartSPREADER™ Tow Behind

#### STANDARD FEATURES

- Extra large 130 lbs. hopper capacity to finish projects faster.
- Professional-style, easy-set controls for precise application.
- Enclosed commercial-grade gearbox for smooth rolling and easy maintenance.
- Large pneumatic tires for easy maneuverability.
- Fast and easy assembly.
- Universal hitch fits any lawn tractor regardless of brand.

Part No.	Description	Weight
GMR45-0463	Tow Behind Spreader	37 lbs.





# Spreaders



## **GMR45-0548** Ice Melt Push Spreader 130 lbs.

### STANDARD FEATURES

- Rustproof poly hopper increases product life.
- The provided grate improves material flow and spreader performance.
- The cover keeps material dry no matter the conditions.
- The deflector helps narrow the spread pattern when needed.
- Assembled product size: 48" x 27.2" x 33.7"
- Carton size L x W x H 27" x 25" x 16"

Part No.	Description	Weight
GMR45-0548	Ice Melt Push Spreader	41 lbs.



## **GMR45-0547** Lawn and Garden Tow Spreader 185 lbs.

### STANDARD FEATURES

- Large 13" x 5" pneumatic tires allow for transport over any terrain.
- Rust-proof poly hopper is easy to clean and has a long product life.
- 175 lbs. capacity and durable impeller allow for up to 1 acre (40,000 sq. ft.) of coverage depending on rate of speed and material spread.
- Assembled product size: 43" x 38" x 41"
- Carton size L x W x H 38.7" x 18.25" x 24.9"

Part No.	Description	Weight
GMR45-0547	Tow Spreader	42 lbs.



## **GMR45-0329** 185 lbs. Gallon (Dry) Tow Broadcast Spreader

### STANDARD FEATURES

- Rustproof poly hopper and spreader plate increase product life.
- Hopper capacity 20 gallon (dry)/185 lbs. capacity covers about 1 acre (40,000 sq. ft.).\*
- Extra-large 15" x 6" pneumatic tires with ball bearings for reliability even at high speeds.
- On/off control accessible from ATV seat.
- Up to 12' spread width for reliable coverage.
- 43" x 38" x 41" assembled.

\*Depending on material used and speed of application.



Part No.	Description	Weight
GMR45-0329	20-Gallon (Dry) Tow Broadcast Spreader	58 lbs.
GMP40825	Optional Hopper Cover	

# Spreaders



## GMR45-0288 175 lbs. Tow Drop Spreader

### STANDARD FEATURES

- Hopper capacity 17 gallon (dry) 175 lbs.
- 40,000 sq. ft. coverage; roughly 1 acre\*.
- Rustproof poly hopper increases product life.
- 42" controlled spread width.
- Premium galvanized steel agitator improves durability.
- Pneumatic tires allow for smooth transport.
- 33" x 50" x 28" assembled.

\*Depending on material used and speed of application.



Part No.	Description	Weight
GMR45-0288	17-Gallon (Dry) Tow Drop Spreader	51 lbs.



Agri-Fab® UTV/ATV compatible spreaders contain a gear disengage feature that allows higher transport speeds and longer life.



Agri-Fab® UTV/ATV compatible spreaders include a spreader grate which improves material flow and performance.



## GMRDMS-TR-12V-2.2 145 lbs. ATV Dry Material Spreader - Tow

### STANDARD FEATURES

- 2.2 Cubic Foot Poly Hopper.
- 12 Volt Motor With Variable Speed Control. (GMRVSC-10) & On/Off Switch.
- Stainless Steel Radial 6-Blade Fan.
- Holds up to 145 lbs of Potash or 99 lbs of Urea.
- Can be used with: Fertilizer, Seed, Bait, Powders, Granular, Insecticides, Fungicides, Herbicides, Pellets, Ice Melting Pellets.
- 5 to 45 Foot Variable Spread Width!



GMRVSC-10

**5' - 45' Variable Spread Width!**

GMRVSC-10 can also be purchased separately and works on all 12 volt High-Flo pumps.

Part No.	Description	Weight
GMRDMS-TR-12V-2.2	ATV Dry Material Spreader-Tow (includes GMRVSC-10)	50 lbs.



# Spreaders

## GMRATV-DMS-12V 145 lbs. ATV/Truck Mount Dry Material Spreader

### STANDARD FEATURES

- 2.2 Cubic Foot Poly Hopper.
- 12 Volt Motor With Variable Speed Control (GMRVSC-10) & On/Off Switch.
- Stainless Steel Radial 6-Blade Fan.
- Holds up to 145 lbs. of Potash or 99 lbs of Urea.
- Can be used with: Fertilizer, Seed, Bait, Powders, Granular, Insecticides, Fungicides, Herbicides, Pellets, Ice Melting Pellets.
- 5 to 45 Foot Variable Spread Width!
- Optional receiver hitch available for truck mount.
- Optional rain cover available.



**APPROVED FOR:**

- FERTILIZER
- SEED
- BAIT
- GRANULAR
- INSECTICIDES
- FUNGICIDES
- HERBICIDES
- PELLETS
- ICE MELTING PELLETS



**Speed Control**  
GMRVSC-10  
5' TO 45'



### 5' - 45' Variable Spread Width!

Part No.	Description	Weight
GMRATV-DMS-12V	ATV Dry Material Spreader (includes GMRVSC-10)	50 lbs.

GMRVSC-10 can also be purchased separately and works on all 12 volt High-Flo pumps.

This ATV spreader is perfect for spreading seed, dry granular materials (fertilizers, insecticides, fungicides, herbicides), and ice melting materials. The spreader's variable speed 12 Volt motor allows you to vary the spread width from 5 to 45 feet. Easily cover sidewalks or parking lots with ice melt material or spread fertilizer over odd-shaped sections of lawn. An adjustable slide gate controls the amount of material thrown – open or close with the turn of a handle. The spreader features a 2.2 cubic foot poly hopper, 12 Volt motor with variable speed control, and stainless steel radial 6-blade fan. The frame and mounting brackets are constructed from steel. Holds up to 145 lbs. of potash or 99 lbs. of urea. Includes spreader, controller, wiring harness, mounting brackets, and hardware.

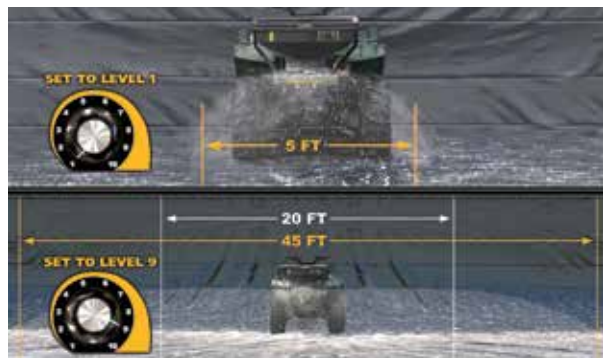

## OPTIONAL DRY MATERIAL ACCESSORIES



**Speed Control**  
GMRVSC-10  
5' TO 45' Spread width.



**Rain Cover**  
GMR5058193



**2" Hitch**  
GMR5301901

ACCESSORIES	
Part No.	Description
GMRVSC-10	Variable Speed Control
GMR5058193	Rain Cover
GMR5301901	2" Receiver Hitch

# Spreaders



## **GMRDMS-3PT-12V-4.5** 220 lbs. Dry Material Spreader 4.5 CU.

### STANDARD FEATURES

- 4.5 Cubic Foot Poly Hopper.
- Stainless Steel Radial 6-Blade Fan.
- Holds up to 220 lbs of Potash.
- Can be used with: Fertilizer, Seed, Bait, Granular, Insecticides, Fungicides, Herbicides, Pellets, Ice Melting Pellets.
- 5 to 45 Foot Variable Spread Width!



Part No.	Description	Weight
GMRDMS-3PT-12V-4.5	Dry Material Spreader 4.5 CU.	90 lbs.



### **LARGE POLY HOPPER**

- 4.5 CU FT Poly Hopper
- Holds Up To 220 Lbs Of Potash



### **VARIABLE SPEED CONTROL**

- Control The Spread Width: 5 Feet To 45 Feet
- 20 Feet Of Wire Harness With Alligator Clips



### **STAINLESS STEEL RADIAL FAN**

- 6 Blade Fan
- Stainless Steel



### **ADJUSTABLE SLIDE GATE**

- Choose The Amount Of Dry Material To Spread
- Easy To Reach Handle



### **CATEGORY 1 HITCH**

- Easily Connects To Your Category 1 Tractor Hitch



# Spreaders



## GMRPT100 Broadcast Spreader, Commercial Type

### STANDARD FEATURES

- Spreading disc, moved by the wheels, has an adjustable spreading width from 1m to 6m (3–20 feet).
- Capacity of 100 liters, 0.13 cu. yards.
- Gear box is in oil bath aluminum.
- Weight (empty) 39 kg.



The trailed fertilizer spreader is a professional machine planned for working in parks, greenhouses, nurseries and little gardens. The spreading disc, moved by the wheels, has an adjustable spreading width from 1 m to 6 m.

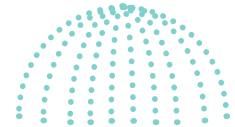

### Lever Extension

Part No.
OTMLEVEREXTENSION

Part No.	Description
GMRPT100	Broadcast Spreader

## Fertilizer Spreader Steel hopper & tubular steel frame designed strong!

### STANDARD FEATURES

- Three spreading patterns to select from.
- Operating levers used to obtain accurate and uniform spread in the desired direction.
- Spreading disc has four adjustable vanes.
- Maximum efficiency and uniform spread for different types of fertilizers and seeds.
- Weldless metal sheet used on hopper.

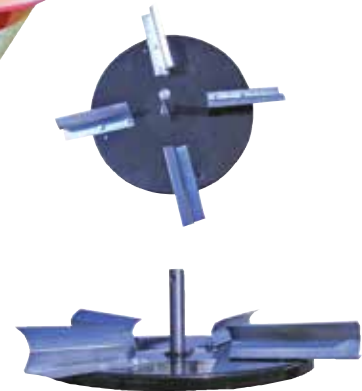

Three spreading patterns to select from using levers.



Spreading disc with four adjustable vanes ensures uniform spread.

Part No.	Hopper Capacity	Spreading Width	Spreading Speed	Weight with PTO Shaft	3 Point Hitch Category	Minimum HP Required
GMRFS150	330 lbs.	16'5" to 26'4"	2-10 mph	152 lbs.	1 or 2	8 to 10
GMRFS300	660 lbs.	16'5" to 26'4"	2-10 mph	163 lbs.	1 or 2	8 to 10
GMRFS500	1,100 lbs.	16'5" to 26'4"	2-10 mph	176 lbs.	1 or 2	8 to 10

### Agitator

Part No.
OTMDELUXEAGITATOR

# Ice Melt

**Jet Blue Ice Melt** Melts at low temperature

**STANDARD FEATURES**

- Formulated to provide a safer choice for pet owners.
- Melts at low temperature — down to -32°C / -26°F
- Melts ice faster using an advanced blend of polyols, organic salts, and bio-additives.
- Suitable for both commercial and residential driveways, porches, sidewalks and steps, Jet Blue is pet-friendly and won't track inside or stain.



Part No.	Description
ACCJETBLUE-5KGSNAKER	5 Kg Shaker Jet Blue Ice Melt
ACCJETBLUE-10KGPAIL	10 Kg Pail Jet Blue Ice Melt
ACCJETBLUE-18KGPAIL	18 Kg Pail Jet Blue Ice Melt

# Lawn Fertilizer



**MIS16-10-3-17-3 - with phosphate** Ground Keeper Lawn Fertilizer

**INGREDIENTS**

- 16% Nitrogen: Your lawn's major requirement for overall growth and development.
- 10% Phosphate: Essential for healthy roots and shoots and critical for photosynthesis.
- 3% Potassium: Like a radiator, creates tolerance to climate conditions, grass hardness.
- 17% Sulphur: Aids in maintaining dark green color and correlates with Nitrogen addition.
- 3% Iron: Necessary for chlorophyll reaction contributes to green coloration of lawn.

Only available by the skid (80 bags) or 1/2 skid (40 bags).

Part No.	Description
MIS16-10-3-17-3	Ground Keeper with Phosphate

BUY THIS,  
WATER THIS,  
BE IMPRESSED!  
  
(WE AND YOUR LAWN  
THANK YOU!)



 Canadian owned,  
Canadian made.



# WESTWARD PARTS

6517 - 67 St.      201 Henderson Dr.      1435 St. James St.  
 Red Deer, AB T4P 1A3      Regina, SK S4N 7E2      Winnipeg, MB R3H 0W9  
 Fax: 1-800-661-4508      Fax: 1-800-721-2977      Fax: 1-800-257-8338

Specifications subject to change without notice or obligation.

# MATERIAL MOVEMENT



- PALLET FORKS
- SKID STEER TRACKS & ATTACHMENTS
- BUCKET TOOTH BAR
- REAR BLADES
- SNOW BLADES
- LANDSCAPE RAKES
- BOX SCRAPERS
- QUICK HITCHES



**WESTWARD PARTS**

# Pallet Forks

## 3-Point Pallet Forks *Quick Hitch Compatible*



### STANDARD FEATURES

These 3 Point Forks are ideal for picking up and moving pallets and bins. Models 1200, 1500 and 2000 are equipped with Category 1, 3-point hitches and 41" length non-adjustable tines and available in 1,200-pound, 1,500-pound, and 2,000-pound capacities. Model 1500-A forks are equipped with 41" length adjustable tines and available in 1,500-pound capacities. Model 3500 forks are equipped with ITA Class II forks and a Quick Hitch compatible Category 1 and 2, 3-point hitches. Fork tines are adjustable from 10" to 36" center to center. The 3,750-pound capacity fork tines are available in 42" and 48" lengths.

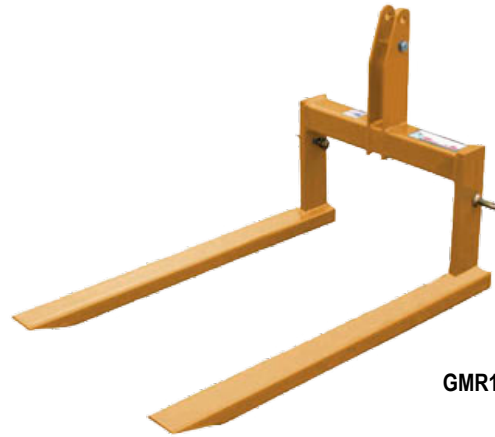

GMR1200

### 3 POINT PALLET FORK SPECIFICATIONS

Models	Lift Capacity	Fork Length	Tine Size	Fork Centers	Weight
GMR1200	1,200 lbs.	41"	2" x 4" x 3/16" Tubing	25"	115 lbs.
GMR1500	1,500 lbs.	41"	1" x 4" Solid	25"	160 lbs.
GMR2000	2,000 lbs.	41"	1-1/4" x 4" Solid	25"	180 lbs.
GMR1500A	1,500 lbs.	41"	1-1/4" x 4" Solid	Adjustable 4" to 26"	300 lbs.
GMR3542	3,700 lbs.	42"	1-3/8" x 4" Solid	Adjustable 10" to 36"	300 lbs.
GMR3548	3,700 lbs.	48"	1-3/8" x 4" Solid	Adjustable 10" to 36"	300 lbs.



GMR1500



GMR1500-A



GMR3500





# Pallet Forks

## Universal Pallet Forks

**STANDARD FEATURES**

- Fits many popular loaders.
- Equipped with a high visibility load guard and adjustable forks.
- Fork tines are constructed of Boron Steel and heat treated.
- All models are equipped with adjustable forks.
- Fork tines available in 42" and 48" usable lengths (model dependent).

UNIVERSAL PALLET FORKS SPECIFICATIONS	
GMRPF-448	
Lift Capacity	4,000 lbs.
Fork Length	48"
Tine Size	1-1/4" x 4" solid
Adj. Fork Features	Standard
Loader Mounts	Fits many loader frames with arms up to 50" C to C
Fork Style	Rail
Weight	438 lbs.
*Requires loader brackets to attach to loader. Call Inside Sales with loader model for pricing and availability.	



Universal

## Pallet Forks To Fit Euro/Global

**STANDARD FEATURES**

- Integrated frame pallet forks with Euro/Global quick attach.
- Equipped with a high visibility load guard and adjustable forks.
- Fork tines are constructed of Boron Steel and heat treated.
- All models are equipped with adjustable forks.

GLOBAL PALLET FORKS SPECIFICATIONS		
	GMRGLPF-448	GMRGLPF-5548
Lift Capacity	4,000 lbs.	5,500 lbs.
Fork Length	48"	48"
Tine Size	1 1/4" x 4"	1 1/2" x 4"
Adj. Fork Features	Standard	Standard
Loader Mounts	Euro/Global quick coupler tractor loaders	Euro/Global quick coupler tractor loaders
Fork Style	Rail	Rail
Weight	350 lbs.	393 lbs.



# Pallet Forks



## Pallet Forks To Fit John Deere Front Loaders

### STANDARD FEATURES

- Skid steer pallet forks (4,000 lbs. or 5,500 lbs.) are offered with a one piece backstop or a step through design for easy cab access and excellent visibility.
- Premium forks include spring loaded latches for easy adjustment spacing.
- Machined rails allow ease of fork spacing adjustment.



JOHN DEERE PALLET FORK SPECIFICATIONS				
	GMRJDPF-2000	GMRJDPF-5442	GMRJDPF-5448	GMRJDPF-6748
Lift Capacity	4,000	4,000	5,500	5,500
Mounting	400 / 500 Series	400 / 500 Series	400 / 500 Series	600 / 700 Series
Fork Spacing	6-40"	6-40"	6-40"	6-40"
Fork Carrier	Beveled Notched Rail	Beveled Notched Rail	Beveled Notched Rail	Beveled Notched Rail
Forks	1.375" x 4" w/Latch	1.375" x 4" w/Latch	1.57" x 4" w/Latch	1.57" x 4" w/Latch
Fork Length	42"	42"	48"	48"
Weight	345 lbs.	359 lbs.	435 lbs.	373 lbs.

## Skid Steer Pallet Forks

### STANDARD FEATURES

- Equipped with a high visibility load guard and adjustable forks.
- Fork tines are constructed of Boron Steel and heat treated.
- All models are equipped with adjustable forks.
- Fork tines available in 42" and 48" usable length.

SKID STEER PALLET FORKS SPECIFICATIONS			
	GMRSSPF-242	GMRSSPF-442	GMRSSPF-448
Lift Capacity	2,000 lbs.	4,000 lbs.	4,000 lbs.
Fork Length	42"	42"	48"
Tine Size	1" x 3" solid	1-1/4" x 4" solid	1-1/4" x 4" solid
Adj. Fork Features	Standard	Standard	Standard
Loader Mounts	Fits skid steer style quick couplers	Universal skid steer mount	Universal skid steer mount
Fork Style	Rail	Rail	Rail
Weight	280 lbs.	375 lbs.	395 lbs.





# Bucket Forks

## Clamp-On Bucket Forks *Clamp-On Bucket Forks*

### STANDARD FEATURES

Built to meet the demands of today's acreage owner. Sturdy construction provides outstanding performance over years of service.

Easy on/off design offers the utmost in convenience when moving palletized materials.

- Mounts to most loader buckets without the use of tools – easy on/off design.
- Rated from 1,000 to 4,000 lbs. Lift is limited by fork capacity or loader capacity, whichever is less.
- Usable fork length of 35 to 42 inches.
- Designed for handling palletized material only.
- “T” handle design saves time when clamping and unclamping forks.
- Each fork has a built-in stake pocket for a 2x4 to be installed as an upright backstop (recommended).
- Sturdy all steel welded construction.
- Completely independent – allows fork adjustment to any pallet width.
- Forks extend 14.5 inches under bucket, 8 inches inside bucket.
- Sold as a pair



	GMRBF-1000	GMRBF-2000	GMRBF-4000
Weight Capacity (lb/kg)	1,000/453.5	2,000/907	4,000/1814
Overall Length (in/cm)	49.5/126	56.5/143.5	56.5/143.5
Usable Tine Length (in/cm)	35/89	42/107	42/107
Tine Size (in/cm)	2x3/5x7.6	2x3/5x7.6	2x4/5x10
Weight (lb/kg)	78/35	102/46	191/87

# Skid Steer Attachments

## Skid Steer Plate *Universal Weld-on Attachment Plate*

### STANDARD FEATURES

Use these universal weld-on attachment plate to convert whatever you want to skid steer quick-attach.

These units are manufactured to interface with most universal skid steer quick attach mounting.



Part No.	Description	Weight (lbs.)
GMRWSP	Standard duty weld-on plate - 1/4". Maximum Capacity 3,500 lbs.*	46
GMRWSP-HD	Heavy duty weld-on plate - 3/8". Maximum Capacity 5,000 lbs.	96
GMR832625	Euro/Global heavy duty weld-on plate - 5/16". Unit measurements are 44.50" x 19.84" Maximum Capacity 5,000 lbs.	95
GMR832630	Euro/Global Weld-on Kit. Individual left and right hand brackets.	36

\*Note: Maximum capacity is that of the adapter bracket. Do not exceed it or loader/tractor operating lift capacity. These are attachment carriers only. Do not use for back dragging.



GMR832625



GMR832630

# Skid Steer Attachments



## Skid Steer Adapters

### STANDARD FEATURES

These all welded designs feature plated handles, springs and lock pins. These adapters provide greater versatility to your choice of attachments. In addition, you can easily switch attachments between a skid steer loader and a tractor loader.



GMR831895

Part No.	Description	Weight (lbs.)
GMR832810	Kubota LA350/401/402/450/452/480/481/482/680/681/LB681/402/552/702 to skid steer adapter	110
GMR832915	Kubota LA852 to skid steer adapter	105
GMR835130	Kubota LA240, LA243 to Skid Steer. Maximum Capacity 1,200 lbs.*	68
GMR832815	Fits John Deere 48/58 loaders with 1-1/4" pins (shipped less pins)	148
GMR831875	John Deere 145/146/148/158 to skid steer adapter	125
GMR831980	John Deere 240/245 260/265 to skid steer adapter	165
GMR832650	John Deere 600/700 to skid steer adapter	140
GMR832620	John Deere 300/400/500 Series to Skid Steer. Maximum Capacity 4,000 lbs.*	132
GMR832631	Euro/Global to John Deere 600/700. Maximum Capacity 5,000 lbs.*	140
GMR835120	Kioti SL2410 to Skid Steer. Maximum Capacity 1,200 lbs.*	67
GMR835145	Mahindra Max 24L to Skid Steer. Maximum Capacity 1,500 lbs.	85
GMR831895	Massey Ferguson 232/236/832/838/1032 to skid steer adapter	148



GMR832810



GMR831980

\*Note: Maximum capacity is that of the adapter bracket. Do not exceed it or loader/tractor operating lift capacity. These are attachment carriers only. Do not use for back dragging.

Adapters continued on following page



GMR835130



GMR831895



GMR832815

# Skid Steer Attachments

## Skid Steer Adapters (Continued)



Part No.	Description	Weight (lbs.)
GMR835250	New Holland 82LB, 84LB, 7614 Loader on NH Bidirectional Tractor to Skid Steer. Maximum Capacity 4,000 lbs.*	250
GMR835255	New Holland 82LB, 84LB, 7614 Loader on NH Bidirectional Tractor to Euro/Global. Maximum Capacity 5,000 lbs.	280
GMR835190	Loaders used on Versatile 160, 256, 276 & Ford 9030 Bidirectional Tractors to Skid Steer. Maximum Capacity 4,000 lbs.*	255
GMR832660	Univ. skid steer adapter for standard pin-on loaders, requires pin-on brt. set	144
GMR832655	Univ. skid steer adapter for compact pin-on loaders, requires pin-on brt. set	140
GMR832820	Fits IH 2250 & 2255 loaders with 1-1/8" pins (shipped less pins)	120
GMR835045	Euro adapter for standard pin-on loader bracket	146
GMR832550	Euro/Global to Skid Steer. Maximum Capacity 4,000 lbs.*	110
GMR835020	Skid Steer to Euro/Global. Maximum Capacity 4,000 lbs.*	145
GMR835080	3-pt. Hitch to Skid Steer Adapter	140
GMR835215	Standard Skid Steer to Mini Universal Adapter	111



GMR835250



GMR835255



GMR835190



GMR832820



GMR835080



GMR832660



GMR832655

*\*Note: Maximum capacity is that of the adapter bracket. Do not exceed it or loader/tractor operating lift capacity. These are attachment carriers only. Do not use for back dragging.*

# Rear Blades



## MCRB-72 Economical 6' blade for tractors

**STANDARD FEATURES**

- An economical 6' blade for tractors up to 35 hp, with Category I 3-pt. hitch.
- The MCRB-72 only offers mechanical angle adjustment.
- The main frame is formed with 3" x 2.5" channel; replaceable straps are used for the A-frame.
- The formed moldboard includes a 1/2" x 6" reversible cutting edge.



MCRB-72 SPECIFICATIONS	
Maximum hp	35 hp
Frame Size	3" x 2.5" Formed Channel
A-Frame	Bolted Straps
3-pt. Hitch	Cat. I
Moldboard Width	6'
Moldboard Height	12"
Moldboard Thickness	1/4"
Cutting Edge – Reversible	1/2" x 6"
Angle/Pivot	360°
Angle Forward (degrees)	0, 15, 30
Angle Reverse (degrees)	0, 15
Offset	N/A
Tilt	N/A
Parking Stand	N/A
Weight	186 lbs.
Optional Item	
GMRSK-5 Skid Shoes	Yes

Part No.	Description	Weight (lbs.)
GMRMCRB-72	6' Rear Blade	186

# Standard Rear Blades

## RB-Series Blades Designed for Cat. I or Cat. I Quick Hitch

**STANDARD FEATURES**

- Designed for Category I or Category I Quick Hitch, these standard duty blades are ideal for the small acreage owner.
- The main frame consists of an all-welded mast and 3" x 3" square tubing.
- The RB-Series features mechanical offset and angle adjustment.
- Angle adjustment is done by simply removing a pin, angling the blade and reinstalling the pin.
- All models have a reversible cutting edge and are supplied with a parking stand for convenient storage.
- Available as an option are skid shoes to assist in cutting height adjustment to reduce the chance of surface damage during snow removal.

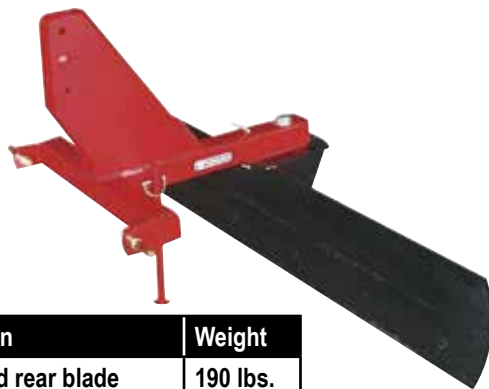

	RB-SERIES SPECIFICATIONS	
	RB-1272	RB-1284
Maximum hp	40 hp	40 hp
Frame Size	3" x 3"	3" x 3"
A-Frame	Welded Mast	Welded Mast
3-pt. Hitch	Cat. I	Cat. I
Moldboard Width	6'	7'
Moldboard Height	12"	12"
Moldboard Thickness	1/4"	1/4"
Cutting Edge – Reversible	1/2" x 6"	1/2" x 6"
Angle/Pivot	360°	360°
Angle Forward (degrees)	0, 15, 30	0, 15, 30
Angle Reverse (degrees)	0, 15	0, 15
Offset	12" R/L	12" R/L
Tilt	N/A	N/A
Parking Stand	Standard	Standard
Weight	190 lbs.	206 lbs.
Optional Item		
SK-5 Skid Shoes	Yes	Yes

Part No.	Description	Weight
GMRRB-1272	6' standard rear blade	190 lbs.
GMRRB-1284	7' standard rear blade	206 lbs.

# Heavy Duty Rear Blades



## RBHD-Series Blades *Designed for Cat. I or Cat. I Quick Hitch*

### STANDARD FEATURES

- Designed for Category I or Category I Quick Hitch, these standard heavy duty blades have the strength required to handle the tough jobs.
- The main frame consists of an all welded mast and 4" x 4" square tubing.
- The RBHD-Series features mechanical offset and angle adjustment.
- Angle adjustment is done by simply removing a pin, angling the blade and reinstalling the pin.
- The RBHD-6-T and RBHD-7-T utilize a 3-position tilt assembly that is easy to use.
- All models have a reversible cutting edge and are supplied with a parking stand for convenient storage.
- Available options are skid shoes to assist in cutting height adjustment to reduce the chance of surface damage during snow removal.
- Optional end plates provide a boxed area for grading.

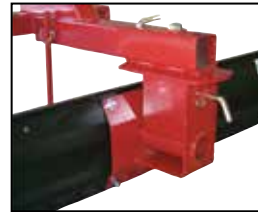

3-position tilt assembly

RBHD-SERIES SPECIFICATIONS				
	RBHD-6	RBHD-7	RBHD-6-T	RBHD-7-T
Maximum hp	50 hp	50 hp	50 hp	50 hp
Frame Size	4" x 4"	4" x 4"	4" x 4"	4" x 4"
A-Frame	Welded Mast	Welded Mast	Welded Mast	Welded Mast
3-pt. Hitch	Cat. I	Cat. I	Cat. I	Cat. I
Moldboard Width	6'	7'	6'	7'
Moldboard Height	14"	14"	14"	14"
Moldboard Thickness	1/4"	1/4"	1/4"	1/4"
Cutting Edge – Reversible	1/2" x 6"	1/2" x 6"	1/2" x 6"	1/2" x 6"
Angle/Pivot	360°	360°	360°	360°
Angle Forward (degrees)	0, 15, 30	0, 15, 30	0, 15, 30	0, 15, 30
Angle Reverse (degrees)	0, 15	0, 15	0, 15	0, 15
Offset	12" R/L	12" R/L	12" R/L	12" R/L
Tilt	N/A	N/A	3 position	3 position
Parking Stand	Standard	Standard	Standard	Standard
Weight	275 lbs.	299 lbs.	306 lbs.	331 lbs.
Optional Items				
GMRSK-8 Skid Shoes	Yes	Yes	Yes	Yes
EP-40 End Plates	Yes	Yes	Yes	Yes

# Heavy Duty Rear Blades

**RB400 Series** Quick Hitch Compatible



Rear Blades are an ideal choice for landscaping, road maintenance, snow removal, feedlot cleaning, irrigation ditching and a wide range of additional uses to suit your needs. They feature rolled moldboards to keep material flowing and reversible heat-treated cutting edges that add to the life of the blade.

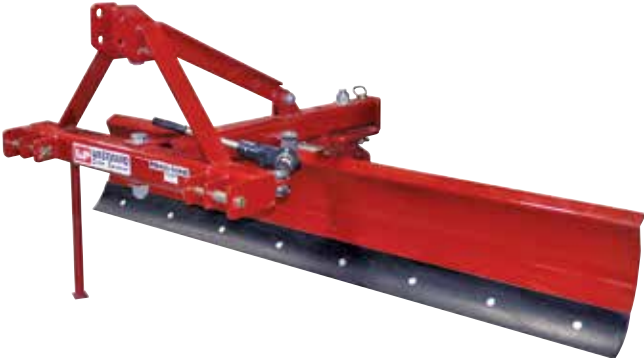

**STANDARD FEATURES**

- Cat 1 hitch.
- Quick hitch compatible.
- Available in 72", 84" & 96" widths.
- Clevis type Cat 1/Cat 2 hitch.
- Rolled-formed moldboard for excellent loading and unloading of soil.
- 5 forward and 5 reverse angle settings.
- 1/2" x 6" high carbon reversible cutting edge.
- Tough powder coat paint.

Part Number	GMRRB400-72	GMRRB400-84	GMRRB400-96
Working Width	72"	84"	96"
Hitch	Cat 1/Cat 2 Clevis	Cat 1/Cat 2 Clevis	Cat 1/Cat 2 Clevis
Moldboard Height	16"	16"	16"
Moldboard Thickness	1/4"	1/4"	1/4"
Moldboard Cutting Edge	1/2" x 6" Reversible	1/2" x 6" Reversible	1/2" x 6" Reversible
Moldboard Offset	24" left or right	24" left or right	24" left or right
Moldboard Tilt	16 degrees - 3 holes	16 degrees - 3 holes	16 degrees - 3 holes
Weight	503 lbs.	541 lbs.	578 lbs.
Max Tractor HP	75	75	75
Parking Stand	Standard	Standard	Standard

# Snow Pusher

**24 Series** Universal Skid Steer Attach



**STANDARD FEATURES**

- Engineered to fit compact tractors equipped with a front loader.
- Replaceable 1" x 6" reversible ultra rubber cutting edge is standard on "R" models.
- All models feature adjustable & reversible skid shoes of high abrasive resistance steel.
- Optional Pull-Back kit available for all models features 1' x 6" ultra rubber cutting edge.
- Models to fit loaders with "Universal" skid steer attaching system.
- HP rating: 25-40 HP

GMRSPPS-2472R SPECIFICATIONS	
Overall Width (in/cm)	78.5 / 199.4
Overall Height (in/cm)	25.6 / 65
Overall Depth (in/cm)	26 / 66
Moldboard Thickness	10-gauge
End Plate Thickness (in/cm)	1/4 / 0.635
Reinforced Endplates	Yes
Rubber Cutting Edge	Yes
Steel Cutting Edge	No
Adjustable/Reversible Skid Shoes	Standard
Horsepower Rating	25-40 HP
Operating Weight of Power Unit	3,500 lbs. Max.



Part No.	Description	Weight (lbs.)
GMRSPPS-2472R	6' Snow Pusher w/Rubber Edge	430





# Snow Blades

## STANDARD FEATURES

- Ideal for residential or commercial snow removal. Use on driveways, parking lots, or other large areas.
- 7.5-ft. & 9-ft. models feature 5° lateral oscillation to allow blade to follow ground contours.
- Two trip springs for controlled break over in snow.
- Reinforced 21" or 27" high 10-gauge moldboards provide long service life.
- 3/8" x 6" cutting edge of 1044 steel.
- Blade locks for light grading of loose dirt or gravel.
- Step-through design allows for easy access to skid steer seat.
- Quick hook up on skid steers or front loaders equipped with "Universal" mounting plate.
- Blade angles right or left.
- Adjustable skid shoes of AR steel are 1/2" thick and rotate for long life.
- Select models integrate either the Euro/Global or John Deere 400/500 series mounting for easier hook up.
- Two bucket clamp-on models for compact tractors.
- SBFL models can be paired with optional brackets for most tractor loaders.



SNOW BLADE SPECIFICATIONS				
	GMR SBS-27108A	GMR SBFL-2790A	GMR SBS-2790A	GMR SBS-2172
Overall width (in/cm)	108/274	90/229	90/229	72/183
Overall height (in/cm)	27/69	27/69	27/69	21/53
Moldboard Thickness	10-gauge	10-gauge	10-gauge	10-gauge
Cutting edge (in/mm) 3/8" x 6"/9.525 x 152.4	Standard	Standard	Standard	Standard
5° Lateral Oscillation	Standard	Standard	NA	NA
Extension trip springs	2	2	2	2
Manual angle positions	NA	5	5	5
Width @ full angle	96/244	80/203	80/203	62/157
Mounting for Tractor Loader (SBFL)	NA	Brackets required*	NA	NA
Mounting for Skid Steer (SBS)	"Universal" Skid Steer	NA	"Universal" Skid Steer	"Universal" Skid Steer
Adjustable Skid Shoes	Standard	Standard	Standard	Standard
Horse power range	50-95 HP	40-80 HP	40-80 HP	<45 HP
Weight (lb/kg)	735/333	660/299	646/293	353/160
Front Loader Angle Hydraulic Kit	NA	Optional GMR360168	NA	NA
Skid Steer Angle Hydraulic Kit	Standard	NA	Optional GMR360165	Optional GMR360170
Crossover Rel. Valve	Standard	Optional	Optional	Optional
Optional Top Deflector	GMR360230	GMR360227	GMR360227	GMR360223
Opt. Sight Indicator	GMR360235	GMR360235	GMR360235	GMR360235
Snow Blade Item No.	GMR360070	GMR360040	GMR360800	GMR360130

\*Optional Interfacing Quick Attach brackets available for most popular loaders.  
Be sure tractor/skid steer is properly counter-balanced.

## Bucket Tooth Bar

### Bucket Tooth Bar *Bucket not included*



#### STANDARD FEATURES

- Designed to fit 60" bucket.
- Installs easily in minutes
- Requires no drilling of holes in bucket
- Fits most common loader buckets
- Increases effectiveness of front loader buckets
- Teeth made of A572 Grade 50 steel
- No. of teeth: 7



Part No.	Description	Weight (lbs)
GMRTB60	Tooth Bar for 60" bucket	53

## Landscape Rakes



### Three Point Hitch Landscape Rake *Sturdy Frame and Construction!*

#### STANDARD FEATURES

- For commercial or home use.
- Use for soil preparation for seeding, distributing or spreading of crushed stone and top soil, clean up of debris such as roots, rocks, etc.
- Sturdy frame construction with heavy duty  $\frac{5}{16}$ " x 1" x 15" standard on both series.
- Five forward – three rear angle positions on the DCR series and seven forward, seven rear on the LRHD series provides for precision leveling and grading.
- Single gauge wheel kit fits DCR and MCR models.
- Dual gauge wheel kit fits MCR-7 and LRHD models.
- Rakes are maneuverable, permitting close work around fences, walls and other objects.
- A "waffle plate" for added strength, supports each tine.



Part Number	Description	Weight (lbs.)
GMRMCR-6	6' Standard Duty Landscape Rake - Category I (40 HP)	187
GMRMCR-7	7' Standard Duty Landscape Rake - Category I (40 HP)	199
GMRLRHD-6	6' Heavy Duty Landscape Rake - Category I (60 HP)	279
GMRLRHD-7	7' Heavy Duty Landscape Rake - Category I (60 HP)	305
GMRLRHD-8	8' Heavy Duty Landscape Rake - Category I (60 HP)	331
GMRSGW-10	*Single gauge wheel kit DCR, MCR	26
GMRDGW-20	*Dual gauge wheel kit MCR-7, LRHD	57

# Box Scraper



**Box Scraper** *Reversible Cutting Edge!*

**STANDARD FEATURES**

- Radius formed 17" moldboard.
- Bucket depth of 21¾".
- ½" x 2½" straps.
- Reversible ½" x 6" cutting edge.
- Height adjustable scarifiers.
- ½" x 2½" heat-treated spring steel shanks.
- Replaceable heat-treated dimpled-on tips.
- Back fill blade.
- Ruggedly built, applicable for site preparation, restoration projects or farm practices.
- Scarifier height can be adjusted to loosen the soil at a desired depth or raised out of the way.
- Reversible cutting edge to scrape material into the box area.
- Heavy duty back fill blade smoothly levels material.



Part No.	Description	Scarifiers	HP Required	Weight (lbs)
GMRSBX-4	4 ft. box scraper Cat 0/1 (3 shanks)	3	18-25	320
GMRSBX-5	5 ft. box scraper Cat I (4 shanks)	4	20-25	378
GMRSBX-6	6 ft. box scraper Cat I (5 shanks)	5	25-40	428
GMRSBX-7	7 ft. box scraper Cat I (6 shanks)	6	25-40	469
GMP 341675	Replacement Tine			

# Cement Mixer



**Hydraulic Concrete Mixer** *Universal Skid Steer Mount*

**STANDARD FEATURES**

- All welded drum construction with internal paddles for uniform mixing and clean dumping.
- Compact, trouble free, long life design with few moving parts.
- Hydraulic motor drive for easy operation and low maintenance requirements.
- Five (5) cu./ft. capacity (1 bag mix).
- Perfect for fence posts, footings, sidewalls and hard to reach areas.
- Direct gearbox drive of drum.
- Welded main frame with "universal" skid steer mount allows easy access to the operators seat.
- Flow control valve allows easy control of speed of the mixer.
- All welded frame with store onboard parking stands for easy storage of the mixer when not in use.



GMRSS-590 SPECIFICATIONS	
Capacity:	Five (5) cu./ft. (1 bag mix)
Drum opening (in/cm):	20 / 51
Overall drum length (in/cm):	32 / 81
Drum construction:	Welded Steel
Drive system:	Hydraulic Direct thru Gearbox
Hydraulic Requirements:	Minimum 8 GPM
Hitch Requirements:	N/A
Drive ratio:	3.18:1
Shield PTO drive:	N/A
Flow Control Valve:	Standard
Connect Under Pressure Couplers:	Standard
Parking stands:	Standard
Shipping weight (lb./kg)	395 / 180

# Quick Hitches



## Category I, II & III Quick Hitches *Adjustable Quick Hitch*

### STANDARD FEATURES

Worksafer Quick Hitches are built for fast, reliable and easy connection (or disconnection) of 3-pt. implements. These Quick Hitches are built to work with implements built to ASAE 3-pt. hitch standards (Cat. I, II, or III). All Quick Hitches feature high strength tubing for torsional strength. Over-center spring-loaded mechanism provides a positive lock yet easy release. A tapered top hitch point bracket allows for easier connection.



GMRQH-101

Part No.	Description	Weight (lbs.)
GMRQH-101	Category I - with adapter (up to 50 HP)	76
GMRQH-102	Category II - with adapter (up to 100 HP)	134
GMRQH-107HD	Category II HD - with adapter (up to 150HP)	160
GMRQH-103	Category III (up to 225 HP)	182
GMRQH-106N	Category III Narrow (up to 225 HP)	176
GMRQH-1023	Allows the use of the Cat. III implements on tractors with Cat. II hitches	185
GMR862500	Category I Adapter Bushing Kit	3
GMR862530	Category II Adapter Bushing Kit	2.2



GMRQH-1023



GMRQH-107HD

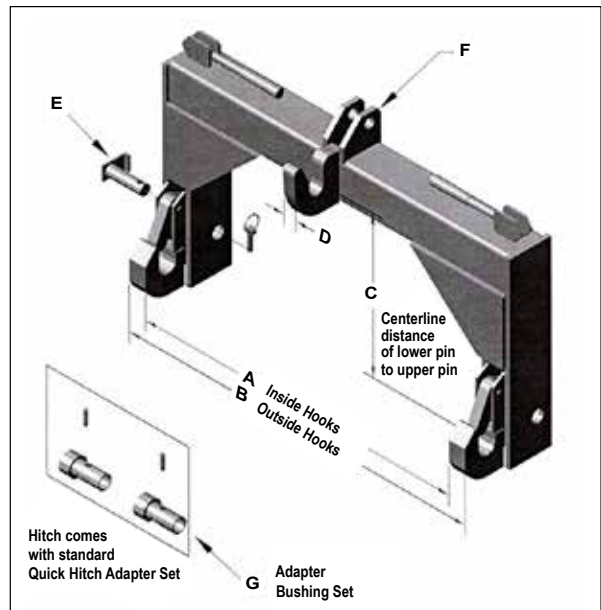

Quick Hitch Specifications (inches unless noted)							
Model	A	B	C	D	E	F	G
GMRQH-101	27.25	29.50	14.50 - 17.50	1.25	7/8	3/4	7/8" to 1-7/16"
GMRQH-102	32.75	36.25	14.88	1.25	1-1/8	1	1-1/8" to 1-7/16"
GMRQH-107HD	32.5	37.75	14.88	1.25	1-1/8	1-1/4	1-1/8" to 1-7/16"
GMRQH-103	38.5	42.75	19	1.25	1-7/16	1-1/4	Not Required
GMRQH-106N	33.25	37.5	19	1.25	1-7/16	1-1/4	Not Required
GMRQH-1023	38.5	42.75	19	1.25	1-7/16	1-1/4	Not Required



# Skid Steer Tracks

## Skid Steer Tracks *Block Pattern / Staggered Lug*

### STANDARD FEATURES

- Perfect for dirt, rip-rap and hard surface applications.
- Most common OEM tread pattern.
- Large lug for great traction
- Built to handle any job while providing good traction.
- Improves traction on difficult working conditions.
- Reduced weight and improved machine efficiency.
- Made with TNT premium engineered rubber compounds.



Part Number	Size (mm)	Width	Pitch (mm)	Links (mm)	Pattern	Application	Weight (lbs)
G MRTNT3208650SDBL	320x86Bx50	320 mm 13 in	86	50	Block	Bobcat T64, T66; Case TR270, 420CT, TR310, 440CT; Takeuchi TL6; John Deere 317G; New Holland C227	370.00
G MRTNT32086T52SDBL	320x86Tx52	320 mm 13 in	86	52	Block	Takeuchi TL8; Gehl CTL60, CTL65	377.00
G MRTNT4008650SDBL	400x86Bx50	400 mm 16 in	86	50	Block	Bobcat T64, T66; Case TR310, 440CT; John Deere 317G	411.40
G MRTNT4008652SDBL	400x86Bx52	400 mm 16 in	86	52	Block	Takeuchi TL10V2; John Deere CT322, CT323, 325G; Kubota SVL65, SVL75	427.86
G MRTNT4508656SDBL	450x86Bx56	450 mm 18 in	86	56	Block	CAT 279D, 289D; Gehl RT210; John Deere 329E, CT332, 333D, E	579.04
G MRTNT4508660SDBL	450x86Bx60	450 mm 18 in	86	60	Block	Bobcat T870 (late model); CAT 299D	620.40

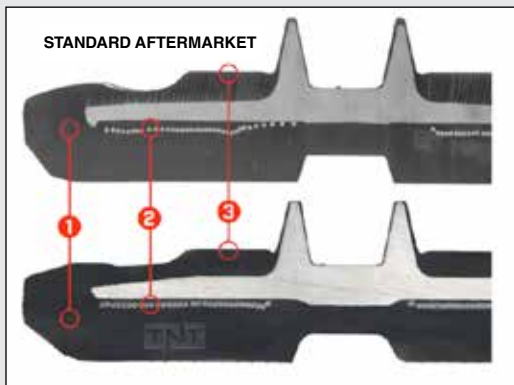

### Standard Aftermarket vs TNT

TNT supplies only the best products to customers. Every rubber track they make has been subject to rigorous quality check and meets or exceeds customer expectations.

This is a comparative cross section sample of a TNT rubber track and a standard aftermarket track:

1. Reinforced Roller Path for longer life
2. Endless Heavy-Duty Steel Cables for thick, uniform cords which provide added strength and longer life
3. Natural Rubber Compounds meaning less filler and better durability

# Skid Steer Tracks



## Skid Steer Tracks C Pattern

### STANDARD FEATURES

- Perfect for muddy conditions and soft dirt.
- Common OEM tread design.
- Multiple biting edges offer excellent traction.
- Made with premium engineered rubber compounds.
- Optimal service life in demanding environments.
- Made with TNT premium engineered rubber compounds.



\* All tracks listed are Standard Duty

Part Number	Size (mm)	Width	Pitch (mm)	Links (mm)	Pattern	Application	Weight (lbs)
GMRTNT1807239SDC	180x72x39	180 mm 7 in	72	39	C	Bobcat MT50, 52, 55; Ditch Witch JT5, 520, SK500; Vermeer S600TX	565.77
GMRTNT3208649SDC	320x86Bx49	320 mm 13 in	86	49	C	Bobcat T550, T590, T595; CAT 239D, 249D; Gehl RT165	343.49
GMRTNT3208652SDC	320x86Bx52	320 mm 13 in	86	52	C	Bobcat T650; Takeuchi TL10V2; John Deere CT319, CT322, 325G; Kubota SVL65, SVL75	364.52
GMRTNT4508652SDC	450x86Bx52	450 mm 18 in	86	52	C	Bobcat T650	537.68
GMRTNT4508655SDC	450x86Cx55	450 mm 18 in	86	55	C	Bobcat T740, T750, T770; Case TR340, TV370, TV380; New Holland C232, C238	568.70
GMRTNT4508658SDC	450x86Bx58	450 mm 18 in	86	58	C	Bobcat T870 (early model); Gehl RT250; John Deere 331G, 333G; Kubota SVL90, SVL95	599.72

### Track sizing and part numbers:

The part numbers for rubber tracks corresponds with important measurements that allow the track to fit on each machine's undercarriage.

See example below:

#### TNT Part Number



Brand



Track Width (mm)



Track Pitch (mm)



Track Links (mm)



Duty Class



Block Tread Pattern

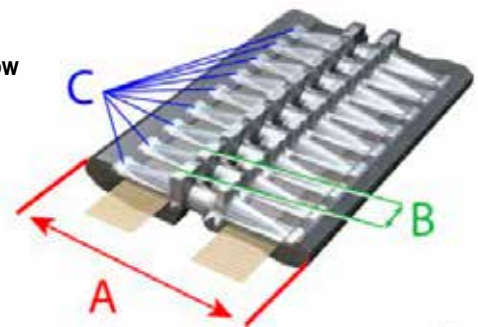

# WESTWARD PARTS

6517 - 67 St.  
Red Deer, AB T4P 1A3  
Fax: 1-800-661-4508

201 Henderson Dr.  
Regina, SK S4N 7E2  
Fax: 1-800-721-2977

1435 St. James St.  
Winnipeg, MB R3H 0W9  
Fax: 1-800-257-8338

Specifications subject to change without notice or obligation.

# TILLAGE EQUIPMENT

- ARENA GROOMERS
- CULTIVATORS
- HARROWS
- AERATORS
- RAKES
- PLOWS
- ROTOTILLERS



**WESTWARD PARTS**

# Harrows



## S3 Delta Harrows Typical applications, unlimited flexibility

This product is good for customers who are looking for inexpensive terrain management options. In sizes most suitable for towing with ATV's or lawn tractors, this multi-tool can be easily customized by the user to agitate surfaces with three different levels of aggression.

The secret is in the design of the tine, which tackles contours and debris without bridging or plugging. Meanwhile, the tines accomplish a variety of improvements:

- Resurface roads and arenas
- Aerate and dethatch turf (lawns, pastures)
- Distribute and smooth animal droppings or mounds
- Incorporate chemical or moisture
- Prepare smooth seedbeds

### ALL-SEASON USE:

**Spring:** stand matted foliage up to stimulate growth, loosen thatch and bunched debris, aerate lawns before feed & seed and then harrow afterwards to incorporate and increase germination speed, prep seed beds.

**Summer:** break up dry soil crusts or incorporate moisture, rake pastures or corrals regularly to scatter mounds and stimulate grass, lift longer grass before mowing, rake and smooth dirt or gravel paths and athletic fields.

**Fall:** shred dry leaves, aerate and dethatch lawns.

**Winter:** break up ice crusts and fluff or smooth snow on trails.



Flexible Two-Way design for optimum debris clearance.

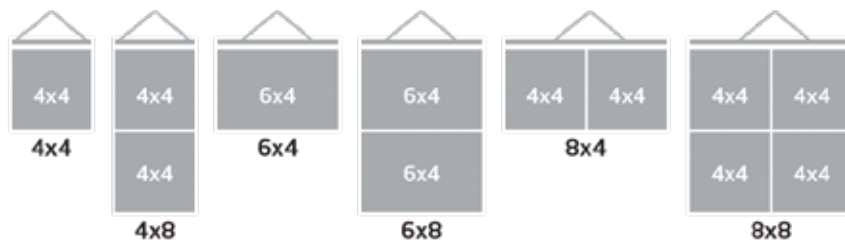

Part No.	Description (W x L)	Tyne Size	Weight
GMR202130	4' x 4' Flexible Harrow	1/2"	95 lbs.
GMR202127	4' x 8' Flexible Harrow	1/2"	152 lbs.
GMR202160	6' x 4' Flexible Harrow	1/2"	129 lbs.
GMR202128	6' x 8' Flexible Harrow	1/2"	245 lbs.
GMR202161	8' x 4' Flexible Harrow	1/2"	150 lbs.
GMR202129	8' x 8' Flexible Harrow	1/2"	318 lbs.

\*Drawbar included.



**Heavy Action**  
Tynes stand at an aggressive 75° angle.

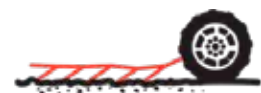

**Medium Action**  
Reversed, tynes have a lighter angle of action.

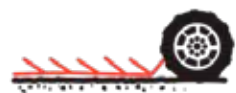

**Light Action**  
Turned over, resulting in a finer leveling effect.



**Dual Action**  
Front section heavy action, rear section levels.



# Harrows



## S3 Delta Harrows Heavy Duty applications

Standard Drawbar Style is the traditional industry choice. It features a flat bar onto which the sections are easily hooked with an "S" shaped connector. Quickly switch the section to aggressive or smoothing mode with this drawbar combination.

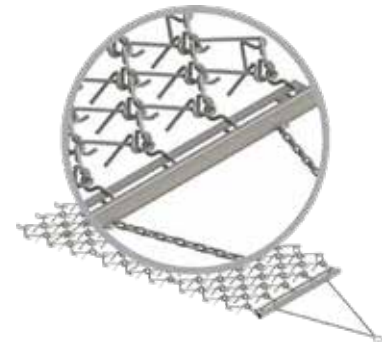
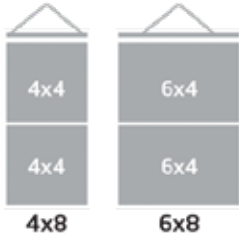

Part No.	Description (W x L)	Tyne Size
GMR24202163	4' x 8' Flexible Harrow	5/8"
GMR24202164	6' x 8' Flexible Harrow	5/8"

\*Drawbar not included.

# Harrows - Diamond

## GMRDH40 & GMRDH60 Harrows - Diamond

### STANDARD FEATURES

- 5/8" teeth.
- Great for pulling behind a quad or ATV.
- Perfect for conditioning horse paddocks.
- Use for weed control and final seedbed preparation.

Part No.	Description	Weight
GMRDH40	Diamond Harrow - 40" x 52" has 20 (5/8") teeth	62 lbs.
GMRDH60	Diamond Harrow - 60" x 52" has 30 (5/8") teeth	98 lbs.

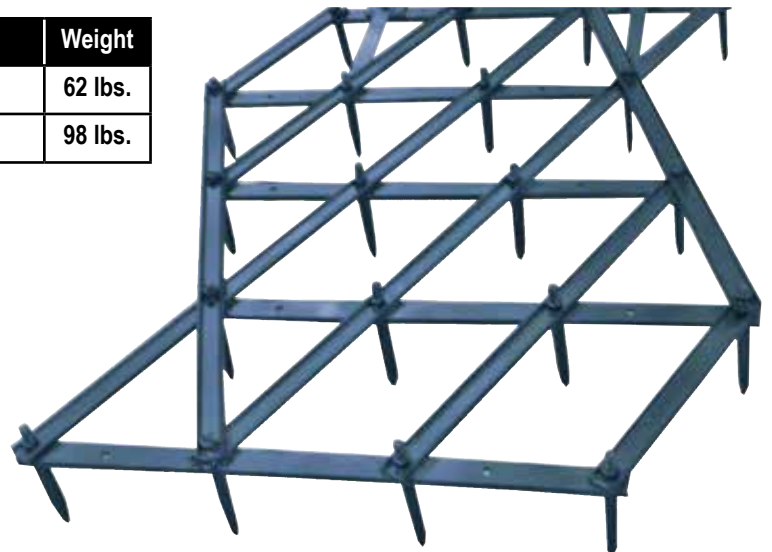

# Arena Vator III

**NEW!**



**QUICK HITCH COMPATIBLE**

## AV3 SERIES

**FEATURES:**

- Adjustable 12" rear pipe roller
- 4" diameter adjustable leveling bar
- Two rows heavy duty S-tines with reversible points
- Frame designed to accept scarifier shank kits

MODELS	WORKING WIDTH	NO. OF SHANKS	SHANK SIZE	SHANK CLEARANCE	HITCH	HP REQUIRED	WEIGHT
GMRAV3-4	4'	11	1-1/4" x 3/8" x 22"	16"	Cat.1	18 to 32	400
GMRAV3-5	5'	13	1-1/4" x 3/8" x 22"	16"	Cat.1	20 to 32	480
GMRAV3-6	6'	15	1-1/4" x 3/8" x 22"	16"	Cat.1	25 to 39	550
GMRAV3-7	7'	17	1-1/4" x 3/8" x 22"	16"	Cat.1	30 to 47	660
GMRAV3-8	8'	19	1-1/4" x 3/8" x 22"	16"	Cat.1 & 2	35 to 53	745
GMRAV3-10	10'	23	1-1/4" x 3/8" x 22"	16"	Cat.1 & 2	40 to 60	930
GMRAV3-12	12'	27	1-1/4" x 3/8" x 22"	16"	Cat.1 & 2	50 to 70	1120

Optional Equipment: Scarifier Shank Kit, Gauge Wheels, Pull-Hitch, 60 Gal. Water Tank w/ Mounting Bkt, Finger Rake in lieu of Pipe Roller & Pipe Leveler

## AV3-M SERIES

**FEATURES:**

- Adjustable 12" rear mesh roller
- 4" diameter adjustable leveling bar
- Two rows heavy duty S-tines
- Frame designed to accept scarifier shank kits



**QUICK HITCH COMPATIBLE**

MODELS	WORKING WIDTH	NO. OF SHANKS	SHANK SIZE	SHANK CLEARANCE	HITCH	HP REQUIRED	WEIGHT
GMRAV3-4M	4'	11	1-1/4" x 3/8" x 22"	16"	Cat. 1	18 to 32	370
GMRAV3-5M	5'	13	1-1/4" x 3/8" x 22"	16"	Cat. 1	20 to 32	460
GMRAV3-6M	6'	15	1-1/4" x 3/8" x 22"	16"	Cat. 1	25 to 39	530
GMRAV3-7M	7'	17	1-1/4" x 3/8" x 22"	16"	Cat. 1	30 to 47	640
GMRAV3-8M	8'	19	1-1/4" x 3/8" x 22"	16"	Cat. 1 & 2	35 to 53	725

Optional Equipment: Scarifier Shank Kit, Gauge Wheels, Pull-Hitch, 60 Gallon Water Tank with Mounting Bracket



AV3 with optional Finger Rake & Gauge Wheels



AV3 with optional Pull-Type Hitch, AV3-4 & AV3-5



AV3 with optional Scarifier Shanks

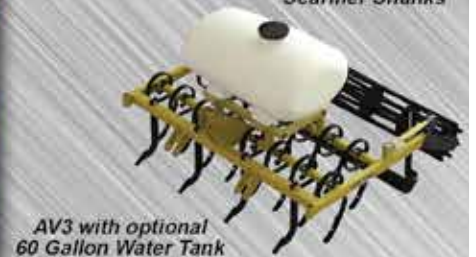

AV3 with optional 60 Gallon Water Tank

# Arena Groomer

**AC Series Arena Comb** *Ideal for horse arenas!*

**STANDARD FEATURES**

- Developed for the highest quality arenas that usually have decomposed granite or ground rubber base under approximately 4" of quality sand.
- Two large 8" wide adjustable flotation gauge wheels for depth control are mounted in front.
- Two rows of heavy-duty vibrating S-tine shanks loosen and aerate the soil.
- Special 3/4" thick steel comb levels, gauges the depth on the rear of the machine and finish combs the sand.
- Quick hitch compatible.



RHE SERIES ARENA-HARROWS SPECIFICATIONS			
MODELS	GMRAC6	GMRAC7	GMRAC8
Working Width	6'	7'	8'
Number of Shanks	15	17	19
Shank Size	1 1/4" x 3/8" x 22"	1 1/4" x 3/8" x 22"	1 1/4" x 3/8" x 22"
Shank Clearance	16"	16"	16"
Quick Hitch	Category 1	Category 1	Category 1 & 2
HP Rating	25 to 40	25 to 50	25 to 60
Weight	430 lbs.	530 lbs.	630 lbs.
Leveling Comb	3/4" x 6"		
Gauge Wheels	18.5 x 8.5		

The AC Series Arena Comb is designed as a light to medium duty tillage tool for working up, leveling and conditioning arenas and tracks.

The Arena-Comb consists of a cultivator frame, two gauge wheels and a leveling comb. It will work the soil, level and condition the surface in one pass.



Equipped with 8" wide flotation wheels. Quick hitch compatible.



Two rows of heavy duty S-tine shanks.

# Heavy Duty Disc Harrows

## DH 300 Series *Quick Hitch Compatible*

### STANDARD FEATURES

- Cat 1 hitch.
- Quick hitch compatible.
- Clevis hitch provides easy hook-up.
- 3" square frame tube.
- 3" square gang tube.
- 3/8" thick bearing hangers with reinforcement.
- 1" square, high carbon steel gang axles.
- Self aligning sealed bearings.
- 7 1/2" disc blade spacing.
- Tough powder coat paint.
- 18" notched or smooth disc blades.



The Disc Harrow is an ideal choice for landscaping, food plotting, gardening, small acreage or general farm tilling. Front and rear gangs are easy to adjust with our built-in adjustment handle. The 7 1/2" disc blade spacing allows the blade to cut evenly over the ground. The 3" square tubing is heavy enough to pull an attachment behind the disc harrow to better level the soil.

Part No.	GMRDH300-72	GMRDH300-84
Working Width	72"	84"
Hitch	Cat 1 Clevis Hitch	Cat 1 Clevis Hitch
Number of Blades	20	24
Disc Blade Size	18"	18"
Disc Blade Spacing	7 1/2"	7 1/2"
Disc Blade Type	Notched or Combination	
Weight	815 lbs.	900 lbs.
Frame Tube	3" Square	3" Square
Bearing Hanger	1/2" Plate Reinforced	
Bearing Type	Self-aligning, sealed bearings	
Gang Tube	3" Square	3" Square
Gang Axle	1" Square	1" Square
Angling	Front gang: 0, 7, 14, 21 degrees w/adjustment handle Rear gang: 0, 7, 14, 21 degrees w/adjustment handle	
HP Required	35	40

# Heavy Duty Core Aerators



## AE 200 Series *Quick Hitch Compatible*

### STANDARD FEATURES

- Cat 1 hitch.
- Quick hitch compatible.
- Powder coat paint.
- Available in 48", 60" & 72" widths.
- 3/4" hardened spoons with closed design.
- Rotor flanges are welded with 2 bronze bushings per rotor.
- 3 Support stands.
- Paired hubs turn independently.
- Six spoons per hub - penetration of 4 1/2".



200 Series Core Aerators help to relieve soil compaction and allow air circulation in grassy surfaces. When your grassy surface begins to suffer the effects of compaction and wear, such as shallow root zones, thatch build-up, worn pathways or water stands, our 20 Series Core Aerator will provide immediate relief.

Part No.	GMRAE200-48	GMRAE200-60	GMRAE200-72
Overall Width	48"	60"	72"
Coring Width	42"	54"	66"
Height	36"	36"	36"
Hitch	Cat 1	Cat 1	Cat 1
# of Spoons	48	60	72
# of Spoons Wheels	8	10	12
# of Hubs	4	5	6
Spoon Penetration	4 1/2"	4 1/2"	4 1/2"
Weight (lbs.)	320	350	400

### Replacement Spoons

Part Number	Description
GMP800101	Aerator Tine

# Single Shank

## GMR200 *Single Shank*

### STANDARD FEATURES

- 4" x 4" x 3/8" tube frame.
- Shear bolt protection.

Part No.	GMR200
# of Shanks	1
Frame Tube Size	4" x 4"
Shank Length	23"
Shank Size	1" x 6"
Hitch	Cat. 1
Max. HP	50
Weight	130



# Rakes



## Three Point Hitch Landscape Rake *Sturdy Frame and Construction!*

### STANDARD FEATURES

- For commercial or home use.
- Use for soil preparation for seeding, distributing or spreading of crushed stone and top soil, clean up of debris such as roots, rocks, etc.
- Rakes are maneuverable, permitting close work around fences, walls and other objects.
- Five forward – three rear angle positions on the DCR series and seven forward, seven rear on the LRHD series provides for precision leveling and grading.
- Sturdy frame construction with heavy duty  $\frac{5}{16}$ " x 1" x 15" standard on both series.
- Single gauge wheel kit fits DCR and MCR models.
- Dual gauge wheel kit fits MCR-7 and LRHD models.
- A "waffle plate" for added strength, supports each tine.



Part Number	Description	Weight (lbs.)
GMRMCR-6	6' Standard Duty Landscape Rake - Category I (40 HP)	187
GMRMCR-7	7' Standard Duty Landscape Rake - Category I (40 HP)	199
GMRLRHD-6	6' Heavy Duty Landscape Rake - Category I (60 HP)	279
GMRLRHD-7	7' Heavy Duty Landscape Rake - Category I (60 HP)	305
GMRLRHD-8	8' Heavy Duty Landscape Rake - Category I (60 HP)	331
GMRSGW-10	*Single gauge wheel kit DCR, MCR	26
GMRDGW-20	*Dual gauge wheel kit MCR-7, LRHD	57

\*Optional

## Replacement Tine

Part Number	Description
GMP341704	Landscape Rake Tine

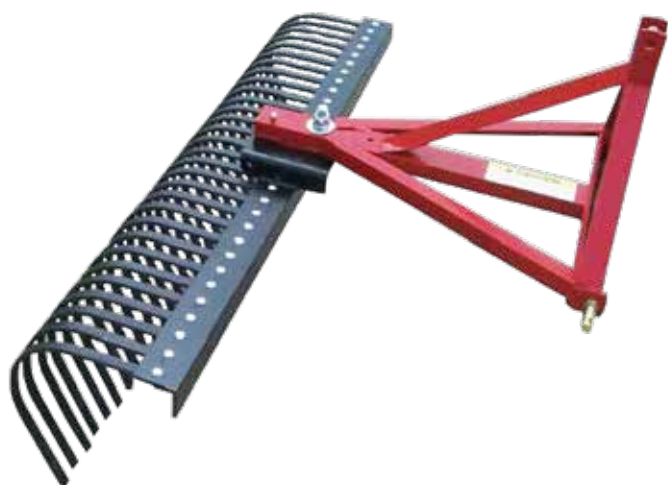

# 3 Pt. Hitch Rototillers

**IAP WESTWARD PARTS**

## TXG Series Rototiller *Compact Rotary Tiller*

### STANDARD FEATURES

- Single speed Gearbox with 540 rpm PTO.
- Rotor revolutions (rpm): 268.
- PTO shaft with clutch (1" 3/8 Z6 tractor side yoke).
- Side Gear drive.
- Universal three point hitch, cat. 1.
- 6 blades per flange.
- Safety guards.



Drive style



Part No.	Working Width	Working Depth	Blade (PCS)	Power (HP)	Input Power (RPM)	Weight	Measurement
GMRTXG40	37"	7"	24	20-35	540	323 lbs.	47" x 26" x 23"
GMRTXG48	47"	7"	30	20-35	540	363 lbs.	56" x 25" x 23"
GMRTXG56	56"	7"	36	20-35	540	394 lbs.	65" x 25" x 23"

## TSG Series Rototiller *Medium Rotary Tiller*

### STANDARD FEATURES

- Single speed Gearbox with 540 rpm PTO.
- Rotor revolutions (rpm): 242.
- PTO shaft with clutch (1" 3/8 Z6 tractor side yoke).
- Side Gear drive.
- Universal three point hitch, cat. 1.
- 6 blades per flange.
- Safety guards.



Drive style



Part No.	Working Width	Working Depth	Blade (PCS)	Power (HP)	Input Power (RPM)	Weight	Measurement
GMRTSG58	55"	7"	42	35-50	540	541 lbs.	65" x 24" x 28"
GMRTSG66	63"	7"	48	35-50	540	594 lbs.	73" x 24" x 28"
GMRTSG74	71"	7"	54	35-50	540	638 lbs.	81" x 24" x 28"
GMRTSG81	79"	7"	60	35-50	540	706 lbs.	89" x 24" x 28"

## 3 Pt. Hitch Rototillers

### RXGU Series Rototiller *Heavy Duty Rotary Tiller*

#### STANDARD FEATURES

- Single speed Gearbox with 540 rpm PTO.
- Rotor revolutions (rpm): 249.
- PTO shaft with clutch (1" 3/8 Z6 tractor side yoke).
- Side Gear drive.
- Universal three point hitch, cat. 1 & cat.2.
- 6 blades per flange.
- Safety guards.

Drive style



Part No.	Working Width	Working Depth	Blade (PCS)	Power (HP)	Input Power (RPM)	Weight	Measurement
GMRRXGU200	75"	8"	60	60-90	540	981 lbs.	87" x 30" x 31"
GMRRXGU220	83"	8"	66	60-90	540	1030 lbs.	94" x 30" x 31"
GMRRXGU240	90"	8"	72	60-90	540	1080 lbs.	102" x 30" x 31"

**WESTWARD PARTS**

6517 - 67 St.  
Red Deer, AB T4P 1A3  
Fax: 1-800-661-4508

201 Henderson Dr.  
Regina, SK S4N 7E2  
Fax: 1-800-721-2977

1435 St. James St.  
Winnipeg, MB R3H 0W9  
Fax: 1-800-257-8338

Specifications subject to change without notice or obligation.



# SPRAYERS AND ACCESSORIES

- BACKPACK SPRAYERS
- TRAILER SPRAYERS
- ATV & UTILITY SPRAYERS
- 3 POINT SPRAYERS
- SKID SPRAYERS
- BOOMS



**WESTWARD PARTS**

## Hand Held Sprayer

### SPWIN1000 Industry ERGO Acid 1000

Part No.	Description
SPWIN1000	Industry ERGO Acid 1000

An acid-resistant sprayer that is also light and handy.



### SPWP3000 Foam Sprayer Axel 3000

Part No.	Description
SPWP3000	Foam Sprayer Axel 3000



## Compression Sprayers

### SPW1232231 1.3 Gallon Handheld Sprayer

#### STANDARD FEATURES

- Working pressure (maximum) 35 PSI (2.4 bar)
- Net weight 3.3 lbs.
- Hose length 64.9 inches
- Spray lance length 13.7 in

For all your quick spot spraying needs!

Part No.	Description
SPW1232231	1.3 Gallon Handheld Sprayer



### SPWP5/PP 1.3 Gallon Sprayer Professional Plus

#### STANDARD FEATURES

- Total Capacity: 1.3 Gallon or 5.70 L.
- 58 PSI
- Net weight 2.20 kg or 4.85 lbs.

Multifunctional, richly equipped, thanks to it you can do more. In one package, you get from us everything you expect from the sprayer.  
 Spraying with natural plant preparations;  
 Spraying with plant protection products;  
 Foliar fertilization of vegetables and herbs.

Part No.	Description
SPWP5/PP	1.3 Gallon Sprayer Professional Plus





# Compression Sprayers

- SPWP5H** 1.3 Gallon Hobby Sprayer
- SPWS023.111** 2.3 Gallon Hobby Sprayer

If you are just starting your adventure with the garden, then the hobby™ sprayer will be perfect for you. It draws from all the most advanced solutions, and the ability to mount each of our lances to it makes it the best choice for start.

- Spraying with natural plant preparations;
- Spraying with plant protection products;
- Foliar fertilization of vegetables and herbs.

	SPWP5H	SPWS023.111
Total Capacity	1.3 Gallon or 5.70 L	2.3 Gallon or 9.50 L
Pressure	58 PSI	58 PSI
Net Weight	3.3 lbs. or 1.50 kg	3.96 lbs. or 1.90 kg



SPWP5H

SPWS023.111

- SPWP7MVTs** 1.8 Gallon Industry Acid Sprayer
- SPWP12MVTs** 3.1 Gallon Industry Acid Sprayer

Heavy industry™ and aggressive chemistry require durability at the highest level. Regardless of pH, the industry sprayers are unbeatable. Resilience and safety are priority when working with hazardous chemicals.

- Neutralization of oils and harmful substances;
- Disinfection of halls and production devices;
- Cleaning and maintenance of stainless steel surfaces;
- Removal of limescale from metal surfaces;
- Removal of rust from metal tanks.

	SPW7MVTs	SPWMVTs
Total Capacity	1.8 Gallon or 6.81 L	3.1 Gallon or 11.73 L
Pressure	58 PSI	58 PSI
Net Weight	4.4 lbs. or 2 kg	5.0 lbs. or 2.30 kg



SPWP7MVTs

SPWP12MVTs

# Manual Backpack Sprayers



## XP SERIES 3 & 4 Gallon Manual Backpack Sprayers

Ultra-comfortable, lightweight professional grade Backpack sprayers. Jacto's new XP range was born from tradition of serving the needs of farmers in some of the most forbidding environments in the world. Jacto's robust XP models require less pumping to achieve maximum operating pressure than just about any other sprayer you can find.

The Jacto XP is an easy-pumping, high (88 PSI) pressure marvel of engineering!



Part No.	Description
SPW1210806	XP Series - White 3 Gallon Manual Backpack Sprayer
SPW1210807	XP Series - White 4 Gallon Manual Backpack Sprayer
SPW1210811	XP Series - Blue 3 Gallon Manual Backpack Sprayer
SPW1210812	XP Series - Blue 4 Gallon Manual Backpack Sprayer

# Manual Backpack Sprayers



## HD 400 SERIES 4 Gallon Manual Backpack Sprayers

Very popular with landscape professionals and organic farmers, the 4-gallon (16-liter) HD400 has an internal mechanical agitator that does an excellent job of keeping powdered chemicals such as kaolin clay organic insecticides in suspension.

The HD400 was independently tested for more than 1,500 continuous hours of operation with no breakdowns and the Jacto HD400 is easily converted for either right-hand or left-hand operation.



Part No.	Description
SPW1210802	HD 400 Series - Blue 4 Gallon Manual Backpack Sprayer
SPW1210803	HD 400 Series - White 4 Gallon Manual Backpack Sprayer

- SPW1210799** PJ16 Blue 4 Gallon Manual Backpack Sprayer
- SPW1210801** CD400 White 4 Gallon Manual Backpack Sprayer

Jacto's 4-gallon (16-liter) CD400 has long been a popular choice among farmers, landscapers, construction crews and others who need extreme toughness and maximum resistance to abusive chemicals.



Part No.	Description
SPW1210799	PJ16 Blue 4 Gallon Manual Backpack Sprayer
SPW1210801	CD400 White 4 Gallon Manual Backpack Sprayer

## SPW1210800 PJH - Blue 5 Gallon Manual Backpack Sprayer

The world's top selling backpack sprayer – and the most imitated backpack sprayer ever.

The PJH has a heavy duty internal brass piston pump, fitted with dual Viton piston cups, accurate tank measurements, locking handle and wand storage, convenient molded in top carry handle and extra large padded adjustable shoulder straps.

No matter what your application, herbicide, fungicide, pesticide or crop nutrient, the PJH is a workhorse sprayer.



Part No.	Description
SPW1210800	PJH - Blue 5 Gallon Manual Backpack Sprayer

# Manual Backpack Sprayers

## **SPP26021XP** 2 Gallon Pro Series Sprayer

### STANDARD FEATURES

- 2-Gallon translucent tank with 4-inch wide mouth opening for easy filling and cleaning.
- Compatible with common fertilizers, weed killers and pesticides.
- Cushion grip shut-off, poly wand and adjustable brass, poly-fan and poly-cone nozzles.
- Shutoff matches most backpack shutoff assemblies.
- Material: Poly
- GPM: 0.4 to 0.5
- PSI: 40 to 60
- Weight: 5.1 lbs



Part No.	Description
SPP26021XP	2 Gallon Pro Series Sprayer

## **SPP61800** Chapin 4 Gallon Pro Series Backpack Sprayer

### STANDARD FEATURES

- 4 gallon translucent tank, weight 10.5 lbs.
- 4" wide mouth opening for easy filling and cleaning.
- Compatible with common fertilizers, weed killers and pesticides.
- 3-Stage filtration system with in-tank removable/cleanable filter.
- Cushion grip poly shut-off and brass nozzle.
- 3 piece nozzle kit for a variety of applications.
- Padded shoulder straps to accommodate a full backpack for hours.
- Applications: General Purpose Cleaning, Fertilizers, Weed & Feed, Fungicides, Herbicides, and Pesticides.



Part No.	Description
SPP61800	4 Gallon Pro Series Backpack Sprayer

## **SPP64800** Chapin Pro Series Diaphragm Pump Backpack Sprayer

### STANDARD FEATURES

- 4 gallon translucent tank, weight 10.5 lbs.
- 4" wide mouth opening for easy filling and cleaning.
- Diaphragm pump provides compatibility with common fertilizers, weed killers and pesticides in both liquid and wettable powder form.
- 3-Stage filtration system with in-tank removable/cleanable filter.
- Cushion grip poly shut-off and brass nozzle.
- Padded shoulder straps and lumbar support for comfort.
- Applications: Wettable Powders, Powders, and General Purpose Cleaning.



Part No.	Description
SPP64800	4 Gallon Pro Series Diaphragm Pump Backpack Sprayer

# Backpack & Handheld Sprayers



Part No.	Description
SPWHH1	1.2 litre handheld sprayer. Easy to use handheld sprayer ensures precise application.
SPWHH6	6.5 litre handheld sprayer Lightweight handheld sprayers ensure reliable application of products like liquid fertilizer, and pest control.
SPWHH8	8.0 litre handheld sprayer Lightweight handheld sprayers ensure reliable application of products like liquid fertilizer, and pest control.
SPWBP16	16.0 litre backback sprayer The Backpack Sprayer is ideal for use as a lawn sprayer, garden sprayer, weed sprayer, chemical sprayer, spot sprayer, and fertilizer sprayer.

# Industrial Concrete Sprayer

**SPP1949** Chapin 3.5 Gallon Industrial Concrete Open Head Sprayer

Chapin's 1949 open head form oil sprayer is the best selling unit and is unmatched for quality. It's compatible for most professional concrete applications and extreme chemicals.

**STANDARD FEATURES**

- 3.5-gallon Tri-Poxy tank - triple protection against rust, corrosion, and damage from dents.
- Chemical-resistant seals.
- 4-inch wide mouth opening for easy filling and cleaning.
- 48-inch reinforced hose with threaded fittings.
- Brass pump, wand, nozzle and shut-off with lock-on feature.
- Unique Tri-Lock seal feature that locks the pump cap tight.
- Applications: form oil, concrete additives.

Part No.	Description
SPP1949	3.5 Gallon Industrial Concrete Open Head Sprayer



# Battery Powered Backpack Sprayers



## **SPW1230663** *PJB-8C Series - 2 Gallon Battery Powered Shoulder Carry Sprayer*

The PJB-8c combines technology and ease of use in a very compact size. This 2 gallon shoulder carry sprayer is perfect for use in small plot growing and tight spaces such as greenhouses, border control in landscapes or plantscape environments in office buildings. Homeowners will like it's lightweight and ease of use for around their home gardens, fruit trees or just general weed control. Whether you need to apply fungicides, pesticides or herbicides, this lightweight easy to use sprayer will do the job efficiently and with less effort as compared to pump-up compression sprayers.

Part No.	Description
SPW1230663	2 Gallon Battery Powered Shoulder Carry Sprayer



## **SPW1272393** *PJB-16 - Blue 4 Gallon Battery Powered Backpack Sprayer*

## **SPW1272385** *PJB-20 - Blue 5 Gallon Battery Powered Backpack Sprayer*

### STANDARD FEATURES

- Full battery charge in 4 hours.
- Average run time - 8 hours.
- Horizontal Spray 30 Ft.
- Vertical Spray 25 Ft.

Part No.	Description
SPW1272393	PJB-16 Blue 4 Gallon Battery Powered Backpack Sprayer
SPW1272385	PJB-20 Blue 5 Gallon Battery Powered Backpack Sprayer

**NEW!**

## **SPW1277571** *DJB-16 Blue 4 Gallon Battery Powered Backpack Sprayer*

## **SPW1236352** *DJB-20 Blue 5 Gallon Battery Powered Backpack Sprayer*

### STANDARD FEATURES

- Full battery charge in 4 hours.
- Approximately 50 Gallons per charge.

Part No.	Description
SPW1277571	DJB-16 Blue 4 Gallon Battery Powered Backpack Sprayer
SPW1236352	DJB-20 Blue 5 Gallon Battery Powered Backpack Sprayer

**NEW!**



# Battery Powered Backpack Sprayers

**SPP63985** 4 Gallon 20V Rechargeable Backpack Sprayer

**STANDARD FEATURES**

- Black & Decker 20-volt Lithium Ion battery.
- Up to 1.75 hours of continuous spraying.
- 4-gallon translucent tank.
- 6-inch wide mouth funnel for easy filling and cleaning.
- 35-40 psi.
- Shoulder straps, Battery, and charger included.
- 20-foot maximum horizontal spray stream and up to 27-foot vertical spray stream.
- Cushion grip shut-off with built-in, serviceable filter to assure that no debris can clog the nozzle tip.
- Applications: General Purpose Cleaning, Fertilizers, Weed & Feed, Fungicides, Herbicides, and Pesticides.



Part No.	Description
SPP63985	4 Gallon 20V Rechargeable Backpack Sprayer

# Vacuum Pump

**SPWW019.131** 12L. Vacuum Pump



Vacuum.pump is a multi-purpose device which can be used for sucking out oil from engines of cars, lawnmowers, chain saws, motorbikes, scooters, personal watercrafts and motorboats as well as for liquidation of any kinds of leakages. It is recommended in conditions where using pressurized air is not advised and in many other untypical situations.

Important advantage: The device does not need an external source of energy (the underpressure is created by hand pumping) and can be used almost everywhere.

Vacuum.pump is light and its construction simple, so it's easy to operate and service. It is equipped in solid, steel wide-diameter ball valve and two kinds of sucking pipes.

**STANDARD FEATURES**

- Strong, polypropylene tank
- Steel valve with high transmitting capacity
- Stainless steel lances
- Sucking polypropylene pipe



Part No.	Description
SPWW019.131	12 L Vacuum Pump

# Westward Parts & FIMCO Catalogue



We are proud to partner with FIMCO to provide our Dealers with a wide variety of top quality products.

To see all FIMCO Sprayer and Sprayer Parts available, contact us to request your Westward Parts & FIMCO Catalogue.



## **WAP WESTWARD PARTS**

6517 - 67 St.  
Red Deer, AB T4P 1A3  
Fax: 1-800-661-4508

201 Henderson Dr.  
Regina, SK S4N 7E2  
Fax: 1-800-721-2977

1435 St. James St.  
Winnipeg, MB R3H 0W9  
Fax: 1-800-257-8338

Specifications subject to change without notice or obligation.

# NORWESCO TANKS

- VERTICAL
- HORIZONTAL
- ELLIPTICAL
- SPECIALTY



**WESTWARD PARTS**

# Storage Tanks



## Vertical Storage Tanks

Vertical storage tanks are most frequently used for bulk storage and mobile nursing applications. Norwesco vertical tanks feature tie-down slots, built-in graduated gallon indicators, an offset fill-opening and a self-vented, slosh-proof lid.



Part No.	Imperial Gallons	Litres	Fitting Size	Diameter	Overall Height	Manway	Weight
SPP41135	160	725	No Ftg	29.5"	71"	8"	60 lbs.
SPP43201	200	909	No Ftg	29.5"	91"	8"	70 lbs.
SPP41057	315	1,430	No Ftg	35"	99"	16"	120 lbs.
SPP41061	500	2,270	No Ftg	48"	84"	16"	150 lbs.
SPP41065	750	3,405	No Ftg	48"	116"	16"	190 lbs.
SPP41067	800	3,632	No Ftg	61"	83"	16"	180 lbs.
SPP41069	900	4,155	No Ftg	48"	148"	16"	250 lbs.
SPP44162	1000	4,540	2"	72"	78"	16"	250 lbs.
SPP41219	1250 Water	5,675	2"	87"	66"	16"	190 lbs.
SPP41221	1250 Premium	5,675	2"	87"	66"	16"	215 lbs.

## Pickup Truck Tanks

Designed to fit in the bed of full-size pickups as well as under a truck canopy, the 270 and 350 sizes have low profiles for better rear vision. They feature fill openings to set to the side of the tank for safety and easy access. A tough circular design adds strength. The 185 gallon tank fits both the "mini" pickups and full-sized models. Depending upon which way the tank is turned, the bottom width can be either 39" or 48". Our pickup truck tanks feature built-in, graduated gallon indicators and slosh-proof lids.



Part No.	Imperial Gallons	Litres	Fitting Size	Length	Width	Overall Height	Manway	Weight
SPP41213	185	823	2"	60"	48"	28"	8"	55 lbs.
SPP40693	270	1,201	2"	62"	49"	32"	8"	80 lbs.
SPP41227	350	1,557	2"	65"	49"	37"	8"	95 lbs.

# Storage Tanks



## Flat Bottom Tanks

Flat Bottom Tanks are designed to be the most rugged and durable utility transport tanks on the market. Unlike other tanks, Flat Bottom Tanks provide all the strength you need for transporting liquids without the use of bands. Tanks should be mounted on at surfaces with full length and width support.



Part No.	Imperial Gallons	Litres	Fitting Size	Length	Width	Overall Height	Manway	Weight
SPP45312	37	165	No Ftg	37.5"	18"	19"	5"	22 lbs.
SPP45315	91	405	1"	48"	35"	18"	5"	60 lbs.

## Low Profile Tanks

The low profile tanks may be used for storage or transport. They are an excellent choice when height limitations are a factor and are the perfect height for putting under your cottage or cabin.



Part No.	Imperial Gallons	Litres	Fitting Size	Length	Width	Overall Height	Manway	Weight
SPP41188	160 Water	712	N/A	80"	46"	15"	8"	75 lbs.
SPP45316	165 Water	735	N/A	60"	48"	20"	8"	80 lbs.
SPP41189	230 Water	1,023	N/A	80"	46"	20"	8"	100 lbs.
SPP44332	250	1,114	No Ftg	62.5"	41.5"	28.5"	8"	98 lbs.
SPP45317	250	1,114	No Ftg	95"	56"	16"	8"	115 lbs.
SPP43123	500 Water	2,225	2"	98"	72"	28.5"	16"	190 lbs.
SPP42890	1075 Water	4,783	2"	131"	84"	36"	16"	350 lbs.
SPP42891	1325 Water	5,896	2"	131"	84"	42"	16"	460 lbs.
SPP44335	2100 Water	9,350	2"	159"	90"	51"	16"	750 lbs.

# Storage Tanks



## Indoor Water Tanks

These tanks have been specially designed with residential and commercial applications in mind. The dimensions of the water tanks allow them to fit through a conventional doorway. The 230 and 350 come standard with a steel support frame. The design of the 330 and 500 imperial gallon tanks allows them to be freestanding/self-supporting and eliminates the need for a steel support frame.



Part No.	Imperial Gallons	Litres	Fitting Size	Length	Width	Overall Height	Manway	Weight
SPP45408	83	370	1-1/4"	36"	18"	43"	5"	40 lbs.
SPP41123	90	400	No Ftg	47"	23"	28"	5"	50 lbs.
SPP41124	180	800	No Ftg	58"	29"	35"	5"	90 lbs.

## Horizontal Leg Tanks

Horizontal leg water tanks feature built-in, graduated gallon indicators and slosh-proof lids. An installed bulkhead fitting is standard in the horizontal tanks.



Part No.	Imperial Gallons	Litres	Fitting Size	Length	Width	Overall Height	Manway	Weight
SPP41092	40	178	No Ftg	42"	20"	23"	5"	20 lbs.
SPP41939	55	245	3/4"	43"	23"	25"	5"	26 lbs.
SPP41183	80	356	No Ftg	59"	23"	26"	5"	45 lbs.
SPP41941	100	445	2"	41"	32"	34"	8"	50 lbs.
SPP41094	125	556	2"	59"	30"	32"	8"	60 lbs.
SPP41943	200	890	2"	55"	38"	40"	8"	75 lbs.

# WAP WESTWARD PARTS

6517 - 67 St.  
Red Deer, AB T4P 1A3  
Fax: 1-800-661-4508

201 Henderson Dr.  
Regina, SK S4N 7E2  
Fax: 1-800-721-2977

1435 St. James St.  
Winnipeg, MB R3H 0W9  
Fax: 1-800-257-8338

Specifications subject to change without notice or obligation.

# WATER, TRANSFER, TRASH, & MINI BULK PUMPS



- CENTRIFUGAL WATER PUMPS
- TRASH PUMPS
- TRANSFER PUMPS
- MINI BULK PUMPS

# Transfer Pump System



## SHURflo® Ag Runner™ Transfer Pump System

The SHURflo AG Runner™ Transfer Pump System is designed to safely and accurately transfer bulk chemicals to the point of use.

### STANDARD FEATURES

Chemical Transfer Pump with 12 VDC motor, 20 ft. cable, alligator clips and in-line fuse (Part# SF-1100-EPDM valves or SF-1105 - Viton valves), electronic flow meter, 1 in. NPT x 12 ft EPDM discharge hose with ball valve/spout, and 1 in. NPT x 12 ft. EPDM inlet hose with 1 in. elbow/ball valve/fitting assembly with locking cam arms.

- Simple and accurate flow indicator
- Industry leading pump
- Portable
- Can be used with a variety of bulk containers
- Built for rugged service with a variety of bulk containers
- Built for rugged service with a heavy-duty welded frame



Part No.	Flow Meter Type
SPWSF-1100-PTS	Pump-mounted (FM-1100)
SPWSF-1100-PTSi	Inline (FM-1100i)
SPWSF-1105-PTSi	Inline (FM-1100i)

# Mini-Bulk Pumps



## SHURFLO® Mini-Bulk Pumps *Designed for efficiency and power*

The SF-1100 Series Bulk Chemical Pumps are the industry leader. They are designed for efficiency and power to handle highly viscous fluids. Servicing the SF-1100 series pump is a rare event, but if needed, it can be serviced quickly and easily with only a few hand tools.

### STANDARD FEATURES

- Specialized EPDM elastics or Viton option.
- 12 volt DC or 110 volt AC motor option.
- 20 foot cord with alligator clips and in-line fuse (DC only).
- Weather protected on/off switch.
- Internal bypass to protect the pump at shut-off.
- 2" MNPT inlet, 1" FNPT outlet.
- Capable of priming up to 12 feet.

Part No.	Valves	Motor
SPWSF-1100-110V	EPDM	110 VAC
SPWSF-1105	Viton	12 VDC



Model	PSI	BAR	GPM	L/min	Amps
SPWSF-1105	0	0.0	10.7	40	9.3
	5	0.3	10.1	38	10.3
	10	0.7	8.7	33	12.3
	15	1.0	7.6	29	13.9





# Hydraulic Pumps



## SPP200PIHY 2" Cast Iron Hydraulic Pump

Cast iron construction for rugged dependable service. Hydraulic Fluid Capacity (Min: 6 gallons/Max 10 gallons). Open or closed system with a 12 HP motor. Replaceable inlet and outlet flanges, and dynamically balanced impellar .Recommendation is to use the motor spool control valve or a suitable equivalent. The lack of such a valve in this circuit may cause failure to the hydraulic motor.

**CAUTION-WARNING:** Please do not run pumps dry, restrict or reduce port sizes or dead head pumps. This could cause component failure to pump.  
**DO NOT USE WITH FLAMMABLE LIQUIDS.**

**STANDARD FEATURES**

- Machine type: Poly Pumps
- Mfr Part #: 200PIHY
- Pressure Range: 12
- GPM: 170 GPM
- Inlet: F NPT
- Series: 2" Cast Iron Pumps w/ Hydraulic Motors



Part No.	Max GPM	Min GPM	Max PSI
SPP1543P-130SP	10	6	40

## SPP200PHYV 2" Poly Hydraulic Pump-FKM

## SPP300PHYV 3" Poly Hydraulic Pump-FKM

**CAUTION-WARNING:** Please do not run pump dry, restrict or reduce port sizes, or dead head pump. This could cause component failure to pump.  
**DO NOT USE WITH FLAMMABLE LIQUIDS.**

**STANDARD FEATURES**

- Material: Polypropylene
- Style: Hydraulic Pump
- 12 H.P. Motor
- Hydraulic fluid capacity - Maximum 10 Gallons.
- Open or closed system.
- 3600 R.P.M.



Part No.	Description	Weight
SPP200PHYV	2" Poly Hydraulic Pump-FKM	24.5 lbs.
SPP300PHYV	3" Poly Hydraulic Pump-FKM	NA

# Poly Pump with Engine



## **SPPM300PH6** 3" Poly Manifold Pump

### STANDARD FEATURES

- EPDM Standard
- Precision molded construction.
- Lightweight
- Corrosion resistant
- Superior design
- Low maintenance
- Type: Polypropylene Pumps
- Style: Gas Engine & Pump
- Size: 3"
- Weight: 45.4 lbs



Part No.	Description
SPPM300PH6	3" Poly Manifold Pump w/ 6.5 Hp Honda® Engine

## **SPW300PH-6** 3" Poly Pump

### STANDARD FEATURES

- Corrosion resistant
- High performance impellers
- High strength polypropylene
- Lightweight — portable
- Type: Polypropylene Pumps
- Style: Gas Engine & Pump
- Size: 3"
- Weight: 50 lbs.



Part No.	Description
SPW300PH-6	3" Poly Pump w/ 6.5 HP Honda® Engine

## **SPP200P6PROE** 2" Poly Pump W/ 6.5hp Intek Pro W/ Electric Start

### STANDARD FEATURES

- Precision molded construction
- Lightweight and Corrosion resistant
- EPDM Standard, FKM :available
- Electric start provides easy of use
- No strain or struggle of pull start
- Easier to power in difficult to reach positions
- Type: Polypropylene Pumps
- Style: Gas Engine & Pump
- Size: 2"



Part No.	Description
SPP200P6PROE	2" Poly Pump w/ 6.5 HP Intek Pro w/ Electric Start



# 3" Transfer Pumps

**HYPRO®**

**Series 1543P** 3" Polypropylene Transfer Pumps

Hypro self-priming centrifugal transfer pumps handle big, high capacity, liquid transfer jobs with ease. The line of pumps offer flow rates from 150 gpm up to 440 gpm to make short work of jobs such as filling nurse tanks, watering seedbeds and transferring liquids.

The durable and powerful line includes polypropylene, aluminum and cast iron models. Use them for transferring water, liquid fertilizers and other chemicals compatible with pump materials. Polypropylene is a lightweight option that provides excellent resistance to corrosive chemicals. Aluminum is an economical choice for water transfer. Cast Iron is most suitable for rugged applications.

Hypro transfer pumps share these features:

- Low oil sensor prevents engine seizing when oil level is too low (gas engine models)
- Easily handles high capacity liquid transfer jobs up to 440 gpm
- Self-priming capabilities
- Cast iron impellers (in cast iron models) and Nylon impellers, constructed for improved strength, can handle solid particles in suspension up to 3/8" diameter.
- Gas engine-driven versions powered by field proven 13 HP Hypro PowerPro™ engine or Honda GX390.
- Housing: 3" x 3" Polypropylene.
- Pump Seals: EPDM Mechanical.
- Suction lift: 25 ft./7.62 m.
- Poly impeller with stainless steel insert.



SPP1543P-130SP

Part No.	Max GPM	Max PSI	Port Size	Engine Mfg. & HP
SPP1543P-130SP	440	54	3" x 3"	PowerPro 13 HP
SPP1543P-130ESP	440	54	3" x 3"	PowerPro 13 HP w/ elec. start
SPP1543P-390EHSP	440	54	3" x 3"	Honda GX390 w/ elec. start

Achieve the highest performance available in a 3" poly transfer pump (up to 484 GPM) with the highest efficiency and horsepower on the market. Ideal for nurse tank and transfer and other closed system applications. The polypropylene housing and EPDM elastomers protect the pump from most chemicals and corrosive environments.

**U.S. Units**

GPM at 0 PSI	GPM at 10 PSI	GPM at 20 PSI	GPM at 30 PSI	GPM at 40 PSI	GPM at 50 PSI	GPM at 58 PSI
440	400	338	269	184	68	0

**Metric Units**

LPM at 0 BAR	LPM at 0.7 BAR	LPM at 1.4 BAR	LPM at 2.1 BAR	LPM at 2.8 BAR	LPM at 3.4 BAR	LPM at 4.0 BAR
1666	1514	1279	1018	697	257	0

# Chemical Transfer Pump

**SPPNP-2065HR** 2" Chemical Transfer Pump

**SPPNP-3065HR** 3" Chemical Transfer Pump

Versatile pump system that can move water as well as a variety of chemicals such as liquid fertilizer. Commercial Honda engine with excellent weight to power ratio. Designed to be used all day, everyday. Fiberglass-reinforced polyester pump body construction withstands agriculture and industrial chemicals that would corrode aluminum pumps. Steel roll cage protects the machine and provides ergonomic hand holds to easily maneuver it. Built-in data plate includes all the key information the user would need to operate.

	SPPNP-2065HR	SPPNP-3065HR
Fuel Capacity	0.82 GAL (3.1L)	0.82 GAL (3.1L)
Impeller	Fiberglass Reinforced Poly	Fiberglass Reinforced Poly
Suction Lift	26'	26'
Total Lift	115'	92'
Series	Commercial	Commercial
Pump	Fiberglass Reinforced Poly	Fiberglass Reinforced Poly
CC	196	196
Weight	60 lbs.	64 lbs.
Engine	Honda GX200	Honda GX200
GPM	154	265



**SPPNP-2070R** 2" Chemical Transfer Pump

**SPPNP-3070R** 3" Chemical Transfer Pump

	SPPNP-2070R	SPPNP-3070R
Fuel Capacity	0.95 GAL (3.6L)	0.82 GAL (3.1L)
Impeller	Fiberglass Reinforced Poly	Fiberglass Reinforced Poly
Suction Lift	26'	26'
Total Lift	115'	96'
Series	Workshop	Workshop
Engine	Powerease	Powerease
Pump	Fiberglass Reinforced Poly	Fiberglass Reinforced Poly
CC	223	223
Weight	60 lbs.	64 lbs.
GPM	154	265



# Water Transfer Pump

**SPPWP-2070S** 2" - 7 HP Power Ease Water Pump

**SPPWP-3070S** 3" - 7 HP Water Transfer Pump

Extremely popular, general purpose pump that quickly moves large volumes of water. Rugged and reliable Powerease engine drives the pump with plenty of power. The pump body is made with aluminum to lower weight, and has a cast iron impeller for strength. Steel roll cage protects the machine and provides ergonomic hand holds to easily maneuver it. Built-in data plate includes all the key information the user would need to operate.

	SPPWP-2070S	SPPWP-3070S
Fuel Capacity	0.95 GAL (3.6L)	0.95 GAL (3.6L)
Impeller	Cast Iron	Cast Iron
Suction Lift	26'	26'
Total Lift	82'	85'
Series	Workshop	Workshop
Engine	Powerease	Powerease
Pump	Centrifugal Aluminum	Centrifugal Aluminum
CC	223	223
Weight	NA	63 lbs.
GPM	158	264



**SPPWP-2050HL** 2" 5.0 HP Honda GC Water Pump

**SPPWP-2065HL** 2" 200CC Honda GX Water Pump

**SPPWP-3065HL** 3" 6.5 HP Honda GX Water Pump

	SPPWP-2050HL	SPPWP-2065HL	SPPWP-3065HL
Fuel Capacity	0.5 GAL (1.8L)	0.82 GAL (3.1L)	0.82 GAL (3.1L)
Impeller	Cast Iron	Cast Iron	Cast Iron
Suction Lift	26'	26'	26'
Total Lift	82'	82'	85'
Series	Commercial	Commercial	Commercial
Engine	Honda GC160	Honda GX200	Honda GX200
Pump	Centrifugal Aluminum	Centrifugal Aluminum	Centrifugal Aluminum
CC	160	196	196
Weight	55 lbs.	62 lbs.	67 lbs.
GPM	158	158	264



# Water Transfer Pump

## **SPPWP-1020R** 1" Water Transfer Pump With Powerease 79 Engine

A lightweight, general purpose pump for those who need to move water. Rugged and reliable Powerease engine drives the pump with plenty of power. The pump body and impeller are both made with aluminum to minimize weight. Mounted on a steel plate with carry handle for ease of storage and transportation while maintaining the stability it needs during operation.

### STANDARD FEATURES

- Fuel Capacity: 0.5 GAL (2L)
- Impeller: Aluminum
- Suction Lift: 23'
- Total Lift: 85'
- Series: Workshop
- Engine: Powerease
- Pump: Centrifugal Aluminum
- CC: 79
- GPM: 42



Part No.	Description
SPPWP-1020R	1" Water Transfer Pump w/ Powerease 79 Engine

## **SPPHP-2065HR** High Pressure Water Pump

Powerful pump system that increases pressure to deliver water over a longer distance. Commercial Honda engine with excellent weight to power ratio. Designed to be used all day, everyday. Steel roll cage protects the machine and provides ergonomic hand holds to easily maneuver it. Built-in data plate includes all the key information the user would need to operate. Higher pressure pump that displaces water like normal pumps, but also has the ability to spray water with the correct attachments.

SPRAY ATTACHMENTS (SOLD SEPARATELY): Fire Hose Kit 50.400.001 Hose Adapter 50.015.007

### STANDARD FEATURES

- Fuel Capacity: 0.82 GAL (3.1L)
- Impeller: Aluminum
- Suction Lift: 26'
- Total Lift: 197'
- Series: Commercial
- Engine: Honda GX200
- Pump: Centrifugal Aluminum
- CC: 196
- GPM: 126
- Weight: 73 lbs.



Part No.	Description
SPPHP-2065HR	High Pressure Water Pump, 2" Ports 6.5 HP Honda

# Water Transfer Pump

## **SPPHP-2013HR** 2" High-Pressure Water Transfer Pump With Honda GX390 Engine

Powerful pump system that increases pressure to deliver water over a longer distance. Commercial Honda engine with excellent weight to power ratio. Designed to be used all day, everyday. Steel roll cage protects the machine and provides ergonomic hand holds to easily maneuver it. Built-in data plate includes all the key information the user would need to operate. Higher pressure pump that displaces water like normal pumps, but also has the ability to spray water with the correct attachments.

### STANDARD FEATURES

- Fuel Capacity: 1.8 GAL (6.1L)
- Impeller: Heavy Duty Aluminum
- Suction Lift: 26'
- Total Lift: 330'
- Series: Commercial
- Engine: Honda GX390
- Pump: Centrifugal Cast Iron
- CC: 389
- Weight: 140 lbs.
- GPM: 140



Part No.	Description
SPPHP-2013HR	2" High-Pressure Water Transfer Pump w/ Honda GX390 Engine

## **SPPWP4013H** 4" Water Transfer Pump With Honda GX390 Engine 389CC

Powerful general purpose pump that quickly moves large volumes of water. Commercial Honda engine with excellent weight to power ratio. Designed to be used all day, everyday. The pump body is made with aluminum to lower weight, and has a cast iron impeller for strength. Steel roll cage protects the machine and provides ergonomic hand holds to easily maneuver it. Built-in data plate includes all the key information the user would need to operate.

### STANDARD FEATURES

- Fuel Capacity: 6.1L (1.6 US G)
- Engine: Honda GX390
- PSI: 38
- Weight: 112 lbs.
- GPM: 422



Part No.	Description
SPPWP4013H	4" Water Transfer Pump w/ Honda GX390 Engine 389CC

# Trash Pump

## **SPPTP-2065HT** 2" Semi-Trash Transfer Pump With Honda GX200 Engine

Reinforced semi-trash water pump that will handle water with dirt, grit and small rocks. Commercial Honda engine with excellent weight to power ratio. Designed to be used all day, everyday. Reinforced aluminum body and cast iron impellers can handle solids up to 5/8" making this pump ideal for moving dirty water. Steel roll cage protects the machine and provides ergonomic hand holds to easily maneuver it.

Built-in data plate includes all the key information the user would need to operate.

### STANDARD FEATURES

- Suction Lift: 26'
- Total Lift: 85'
- Series: Commercial
- Engine: Honda GX200
- CC: 196
- GPM: 158



Part No.	Description
SPPTP-2065HT	2" Semi-Trash Transfer Pump w/ Honda GX200 Engine

## **SPPTP-3070R** 3" Semi-Trash Transfer Pump With Powerease 225 Engine

Reinforced semi-trash water transfer pump that will handle water with dirt, grit and small rocks. Rugged and reliable Powerease engine drives the pump with plenty of power. Reinforced aluminum body and cast iron impellers can handle solids up to 5/8" making this pump ideal for moving dirty water.

Steel roll cage protects the machine and provides ergonomic hand holds to easily maneuver it.

Built-in data plate includes all the key information the user would need to operate.

### STANDARD FEATURES

- Fuel Capacity: 0.95 GAL (3.6L)
- Impeller: Heavy Duty Cast Iron
- Solid Handling: Up to 1"
- Suction Lift: 26'
- Total Lift: 85'
- Series: Workshop
- Engine: Powerease
- Pump: Centrifugal Aluminum
- CC: 223
- Weight: 90 lbs.
- GPM: 264



Part No.	Description
SPPTP-3070R	3" Semi-Trash Transfer Pump w/ Powerease 225 Engine





# Fuel Transfer Pump



**WSENX25-120NB-AA** 120 Volt Continuous Duty Pump W/ Ultra Hf Nozzle

## 120V AC 25 GPM Continuous Duty Fuel Transfer Pump with Ultra Hi-Flow Auto Nozzle

The NX25-120 continuous duty fuel transfer series allows users to fuel all day with less downtime. The NX25's robust variable speed motor actively adjusts its speed for optimal performance and produces a true 25 GPM flow rate at the nozzle. It reduces long-term damage on wetted components while also improving suction lift. Its low profile, lightweight construction reduces installation time. Intelligent audible tones simplify the troubleshooting process by informing users when and where attention is needed. Its rugged powder-coated paint stands the test of time against even the toughest environmental factors. The NX25 series defines elite efficiency in fuel transfer.



### STANDARD FEATURES

- Continuous duty cycle, transfer fuel all day with no downtime
- Pumps 25% faster, eliminating hours of costly driver downtime while filling up equipment
- Consumes up to 45% less electricity, slashing operating costs and boosting efficiency
- 60% lighter weight, making installation faster and strain free
- 75% reduction in common field repair costs through quality design and construction
- Built-in remote on/off, ideal for tall, above ground tanks

Part Number	Description
WSENX25-120NB-AA	120 Volt Continuous Duty Pump w/ Ultra HF Nozzle

# Transfer Pump

**WSEDF120CAN520-RP** 120v Ac Def Dispensing Pumpw/ Auto Nozzle

## 120V AC 8 GPM DEF Transfer Pump with Auto Nozzle and RPV System

The Fill-Rite DF120CAN520-RP is a 120V AC pump factory mounted to a stainless steel IBC bracket. It is capable of up to 8GPM and designed with EPDM seals proven specifically for DEF/AdBlue, anti-freeze, and water. Included accessories that are compatible with DEF are a 5' suction and 20' discharge hose, automatic nozzle, Micro Matic RVP, and various 1" BSPP fittings and hose clamps.

### STANDARD FEATURES

- Rugged multi-diaphragm technology specifically designed for DEF/AdBlue
- Integral pulsation dampener for smooth flow at point of use
- 30-minute duty cycle for either voltage
- Self priming to 6'
- Flow rate up to 8 GPM
- EPDM seals and stainless steel exterior hardware



Part Number	Description
WSEDF120CAN520-RP	120V AC Def Dispensing Pump w/ Auto Nozzle

## DC PUMPS

**FILL-RITE**  
PROUDLY MANUFACTURED BY TUTHILL

### WSEFR1210HARC 12 Volt DC Pump Arctic Series

#### 12V DC 15 GPM Heavy-Duty Fuel Transfer Pump with Auto Arctic Nozzle

The Fill-Rite FR1210HARC model with NPT fittings is a 12V DC heavy-duty, cast-iron, rotary vane fuel transfer pump that is capable of generating up to 15 GPM. It is designed to handle flammable liquids such as gasoline, diesel, biodiesel blends up to B20, ethanol blends up to E15, kerosene, and mineral spirits. The pump motor utilizes a low amp draw and is thermally protected to prevent overheating. The FR1210HARC model is available with a 3/4" automatic (blue boot) nozzle, 15' arctic fuel hose, 20" - 34" steel telescoping suction pipe, swivel, as well as other accessories. Rated to -40°F/-40°C, this pump has a UL/cUL listed motor. This product is ideal for agriculture, construction, or any industry requiring mobile fuel transfer in cold climates.



##### STANDARD FEATURES

- Adjustable electric junction box rotates 180°
- Reliable, heavy-duty power switch withstands heavy abuse in rugged environments
- Focused weight reduction while preserving expected heavy-duty performance
- Thermally protected motor prevents overheating to maximize motor life
- Premium paint shield for exemplary corrosion resistance
- UL/cUL listed motor

Part Number	Description
WSEFR1210HARC	12 Volt DC Pump Arctic Series

### WSEFR1210HA 12v DC 15gpm Heavy-Duty Fuel Transfer Pump With Auto Red Nozzle

#### 12V DC 15GPM Heavy-Duty Fuel Transfer Pump With Auto Red Nozzle

The Fill-Rite FR1210HA model with NPT fittings is a 12V DC heavy-duty, cast-iron, rotary vane fuel transfer pump that is capable of generating up to 15GPM. It is designed to handle flammable liquids such as gasoline, diesel, biodiesel blends up to B20, ethanol blends up to E15, kerosene, and mineral spirits. The pump motor utilizes a low amp draw and is thermally protected to prevent overheating. The FR1210HA model is available with a 3/4" automatic (red boot) nozzle, 12' fuel hose, 20" - 34" steel telescoping suction pipe, as well as other accessories. This product is ideal for agriculture, construction, or any industry requiring mobile fuel transfer.



##### STANDARD FEATURES

- Adjustable electric junction box rotates 180°
- Reliable, heavy-duty power switch withstands heavy abuse in rugged environments
- Focused weight reduction while preserving expected heavy-duty performance
- Thermally protected motor prevents overheating to maximize motor life
- Premium paint shield for exemplary corrosion resistance
- UL/cUL listed motor

Part Number	Description
WSEFR1210HA	12V DC 15gpm Heavy-Duty Fuel Transfer Pump w/ Auto Red Nozzle

# DC PUMPS



**WSENX25-120NB-AA** 12 Volt High Flow W/ Auto Nozzle

## 12V DC 20 GPM Heavy Duty Fuel Transfer Pump with Ultra Hi-Flow Auto Nozzle

The Fill-Rite FR4210HB model with NPT fittings is a 12V DC heavy-duty, cast-iron, rotary vane fuel transfer pump that is capable of generating up to 20 GPM. It is designed to handle flammable liquids such as gasoline, diesel, biodiesel blends up to B20, ethanol blends up to E15, kerosene, and mineral spirits. The pump motor utilizes a low amp draw and is thermally protected to prevent overheating. The FR4210HB model is available with a 1" Ultra Hi-Flow automatic (red) nozzle, 12' fuel hose, 20" - 34" steel telescoping suction pipe, as well as other accessories. This product is ideal for agriculture, construction, or any industry requiring mobile fuel transfer in cold climates.



**STANDARD FEATURES**

- Adjustable electric junction box rotates 180°
- Reliable, heavy-duty power switch withstands heavy abuse in rugged environments
- Focused weight reduction while preserving expected heavy-duty performance
- Thermally protected motor prevents overheating to maximize motor life
- Premium paint shield for exemplary corrosion resistance
- UL/cUL listed motor

Part Number	Description
WSEFR4210HD	12 Volt High Flow w/ Auto Nozzle

**WSENX25-DDCNB-AA** 12-24 Volt Pump Only Continuous Duty For Fuel Transfer W/ Ultra Hf Nozzle

## 12/24V DC 25 GPM Continuous Duty Fuel Transfer Pump with Ultra Hi-Flow Auto Nozzle

The NX25-DDC Continuous Duty fuel transfer series allows users to fuel all day with less downtime. The NX25's robust variable speed motor actively adjusts its speed for optimal performance and produces a true 25 GPM flow rate at the nozzle. It reduces long-term damage on wetted components while also improving suction lift. Its low-profile, lightweight construction reduces installation time. Intelligent audible tones simplify the troubleshooting process by informing users when and where attention is needed. Its rugged powder-coated paint stands the test of time against even the toughest environmental factors. The NX25 Series defines elite efficiency in fuel transfer.

**STANDARD FEATURES**

- Continuous duty cycle, transfer fuel all day with no downtime
- True 25 GPM, high-flow fuel transfer rates at the nozzle
- 12 to 24V DC dual voltage, accepting a range of DC power
- Lightweight at less than 25 pounds, easing installation and reducing setup costs
- Auto power down after 20 minutes of inactivity, reducing energy costs
- Lower amp draw, saving battery power and extending pump life

Part Number	Description
WSENX25-DDCNB-AA	12-24 Volt Pump Only Continuous Duty For Fuel Transfer w/ Ultra Hf Nozzle



## DC PUMPS

**FILL-RITE**  
PROUDLY MANUFACTURED BY TUTHILL

### WSEDF012CMN520 12 Volt DC Def Dispensing With Manual Nozzle

#### 12V DC 8 GPM DEF Transfer Pump with Manual Nozzle

The Fill-Rite DF012CAN520 is a 12V DC pump factory mounted to a stainless steel IBC bracket. It is capable of up to 8 GPM and designed with EPDM seals proven specifically for DEF/ AdBlue, anti-freeze, and water. Included accessories that are compatible with DEF are a 5' suction and 20' discharge hose, manual nozzle, and various 1" BSSP fittings and hose clamps.

##### STANDARD FEATURES

- Rugged multi-diaphragm technology specifically designed for DEF/AdBlue
- Integral pulsation dampener for smooth flow at point of use
- 30-minute duty cycle for either voltage
- Self priming to 6'
- Flow rate up to 8 GPM
- EPDM seals and stainless steel exterior hardware



Part Number	Description
WSEDF012CMN520	12 Volt DC Def Dispensing w/ Manual Nozzle

### WSEFR4210HARC 12 Volt DC High Flow Pump Arctic Series

#### 12V DC 20 GPM Heavy Duty Fuel Transfer Pump with Auto Arctic Nozzle

The Fill-Rite FR4210HARC model with NPT fittings is a 12V DC heavy duty, cast-iron, rotary vane fuel transfer pump that is capable of generating up to 20 GPM. It is designed to handle flammable liquids such as gasoline, diesel, biodiesel blends up to B20, ethanol blends up to E15, kerosene, and mineral spirits. The pump motor utilizes a low amp draw and is thermally protected to prevent overheating. The FR4210HARC model is available with a 1" automatic (blue boot) nozzle, 18' arctic fuel hose, 20" - 34" steel telescoping suction pipe, swivel, as well as other accessories. Rated to -40F/-40C, this pump has a UL/cUL listed motor and is ideal for agriculture, construction, as well as any industry requiring mobile fuel transfer in harsh cold climates.

##### STANDARD FEATURES

- Adjustable electric junction box rotates 180°
- Reliable, heavy-duty power switch withstands heavy abuse in rugged environments
- Focused weight reduction while preserving expected heavy-duty performance
- Thermally protected motor prevents overheating to maximize motor life
- Premium paint shield for exemplary corrosion resistance
- UL/cUL listed motor



Part Number	Description
WSEFR4210HARC	12 Volt DC High Flow Pump Arctic Series

# DC PUMPS



**WSESD1202HA** 12 Volt DC Pump With Hose And Automatic Nozzle

## 12 Volt DC Pump With Hose And Automatic Nozzle

12V DC, 13 GPM standard duty, cast-iron, rotary vane fuel transfer pump. Designed for gasoline, diesel, biodiesel up to B20, E15, kerosene and mineral spirits.

Includes pump, 3/4" automatic nozzle, 3/4" x 10" hose, 15' 12-gauge 2-wire battery cable, 5' ground wire, 15 1/4 - 29 1/4 2-piece polypropylene suction pipe and elbow. One-year warranty. Made in USA.

**STANDARD FEATURES**

- Up to 13 GPM or 49 LPM
- 1/4 HP motor
- UL/cUL listed pump and motor
- Diesel, Gasoline, Kerosene, E15, Biodiesel up to B20
- 1 year warranty
- 2 in. threaded base for tank mounting
- Heavy duty cast iron construction
- Iron rotor with bronze rotary vanes
- Built-in strainer
- Automatic nozzle
- 10 ft. hose with static wire



Part Number	Description
WSESD1202HA	12 Volt DC Pump w/ Hose And Automatic Nozzle

# AC PUMPS

**WSEFR610HA** 115 Volt AC Pump With Auto Nozzle 15gpm

## 115V AC 15 GPM Heavy-Duty Fuel Transfer Pump with Automatic Nozzle

The Fill-Rite FR610HA is a 115V AC heavy-duty, cast-iron, rotary vane fuel transfer pump that is capable of generating up to 15 GPM. It is designed to handle flammable liquids such as gasoline, diesel, biodiesel blends up to B20, ethanol blends up to E15, kerosene, and mineral spirits. The pump motor utilizes a low amp draw and is thermally protected to prevent overheating. The FR610HA model is available with a 3/4" automatic (red boot) nozzle, 12' UL fuel hose, 20" - 34" steel telescoping suction pipe, as well as other accessories. With UL/cUL listed pump and motor, this product is ideal for agriculture, construction, or any industry requiring mobile fuel transfer.

**STANDARD FEATURES**

- Adjustable electric junction box rotates 180°
- Reliable, heavy-duty power switch withstands heavy abuse in rugged environments
- Focused weight reduction while preserving expected heavy-duty performance
- Thermally protected motor prevents overheating to maximize motor life
- Premium paint shield for exemplary corrosion resistance



Part Number	Description
WSEFR610HA	115 Volt AC Pump w/ Auto Nozzle 15 GPM

## AC PUMPS

**FILL-RITE**  
PROUDLY MANUFACTURED BY TUTHILL

### **WSEFR4210HARC** 115 Volt AC Pump w/ Auto Nozzle 20 GPM

#### 115V AC 20 GPM Heavy-Duty Fuel Transfer Pump With Auto Nozzle

The Fill-Rite 710V Series AC heavy-duty fuel transfer pumps lead the industry in performance and longevity. Designed with all cast-iron construction, thermal overload protection, and provided in a variety of supplied configurations, it's no surprise why the FR710V Series is considered the most dependable AC pump in the industry. You name the application and the durability and dependability of Fill-Rite's 20 GPM FR710V Series will meet the challenge. These rugged pumps are also backed by the industry's most stringent safety standards like UL/cUL, ATEX, CE.



##### STANDARD FEATURES

- High volume fuel transfer at a rapid 20 GPM
- All cast-iron construction provides rugged durability
- Superior flexibility working with gasoline, diesel, biodiesel, B20, E15, kerosene, and mineral spirits
- Explosion-proof motor and UL listing assure the highest level of safety engineering

Part Number	Description
WSEFR710VB	115 Volt AC Pump w/ Auto Nozzle 20 GPM

### **WSEFR700VARC** 115 Volt AC Pump Arctic Series 20 GPM

#### 115V AC 20 GPM Heavy-Duty Arctic Fuel Transfer Pump with Auto Nozzle

The Fill-Rite 700V Series AC heavy-duty fuel transfer pumps lead the industry in performance and longevity. Designed with all cast-iron construction, thermal overload protection, and provided in a variety of supplied configurations, it's no surprise why the FR700V Series is considered the most dependable AC pump in the industry. You name the application and the durability and dependability of Fill-Rite's 20 GPM FR700V Series will meet the challenge. These rugged pumps are also backed by the industry's most stringent safety standards like UL/cUL, ATEX, CE.



##### STANDARD FEATURES

- High volume fuel transfer at a rapid 20GPM
- All cast-iron construction provides rugged durability
- Onboard thermal overload protection, protecting your pump from overheating
- Superior flexibility working with gasoline, diesel, biodiesel, B20, E15, kerosene, and mineral spirits
- Explosion-proof motor and UL listing assure the highest level of safety engineering

Part Number	Description
WSEFR700VARC	115 Volt AC Pump Arctic Series 20 GPM

# Nozzles



## Automatic Shut-off Nozzle with Red Boot, 3/4" Inlet

Fill-Rite Automatic Nozzles with built-in automatic shut-off fits unleaded fuel vehicles. This nozzle is uniquely designed to meet the requirements of the automotive industry. Heavy-duty aluminum cast construction and red weather-resistant boot ensure this nozzle can handle the toughest environments. Includes grip spring on the spout and angled inlet to reduce hose wear. Compatible with gasoline, diesel, E15, biodiesel, and kerosene. This nozzle is UL/cUL.



- Rugged cast aluminum construction withstands the toughest environments
- Adjustable latch settings help you dial in the flow
- Automatic shutoff reduces the chance for spills
- Multiple color options available

Part Number	Description
WSEN075UAU10	Automatic Shut-Off Nozzle w/ Red Boot, 3/4" Inlet

## Automatic Shut-Off Nozzle with Green Boot, 1" Inlet

Fill-Rite Automatic Nozzles with built-in automatic shut-off are ideal for higher volume truck and equipment refueling operations. Heavy-duty aluminum cast construction and green weather-resistant boot ensure this nozzle can handle the toughest environments. Includes grip spring on the spout and angled inlet to reduce hose wear. Compatible with gasoline, diesel, E15, biodiesel, and kerosene. This nozzle is UL/cUL.



- Rugged cast aluminum construction withstands the toughest environments
- Adjustable latch settings help you dial in the flow
- Automatic shutoff reduces the chance for spills
- Multiple color options available

Part Number	Description
WSEN100DAU12G	Automatic Shut-Off Nozzle w/ Green Boot, 1" Inlet

## Manual Nozzle, 3/4" Inlet

Fill-Rite aluminum manual nozzle with integral hanging hook. Designed for gasoline and diesel. Includes Viton seals and O-rings for smooth valve operation. This nozzle is UL/cUL.

- Durable construction
- Simple operation



Part Number	Description
WSEFRHMN075S	Manual Nozzle, 3/4" Inlet

## Arctic Weather Automatic Shut-Off Nozzle with Blue Boot, 1" Inlet

Fill-Rite Arctic Weather Automatic Nozzles with built-in automatic shut-off are ideal for automotive diesel fuel applications. This nozzle is uniquely designed to meet the requirements of the automotive industry. Heavy-duty aluminum cast construction and blue weather-resistant boot ensure this nozzle can handle the coldest environments down to -40° F. Compatible with gasoline, diesel, E15, biodiesel, and kerosene. One-year warranty. UL/cUL.



- Rugged cast aluminum construction withstands the toughest environments
- Adjustable latch settings help you dial in the flow
- Automatic shutoff reduces the chance for spills
- Multiple color options available
- Designed to operate in temperatures as low as 40°F

Part Number	Description
WSEFRNA100DAU00	Arctic Weather Automatic Shut-Off Nozzle w/ Blue Boot, 1" Inlet

## Hose

### Fuel Transfer Hose, 3/4" x 15'

The Fill-Rite FRH07515 (3/4" x 15', NPT) fuel transfer hose is constructed with an internal spring guard to resist kinking, stainless steel ground wire, fuel-resistant neoprene exterior, and nitrile interior. It is compatible with gasoline, diesel, biodiesel up to B20, ethanol up to E15, and kerosene.

The FRH07520 hose is suitable for all electric fuel transfer pumps.



Part Number	Description
WSEFRH07515	3/4 In X 14 Ft Retail Hose

### Fuel Transfer Hose, 1" x 14'

The Fill-Rite FRH10014 (1" x 14', NPT) fuel transfer hose is constructed with an internal spring guard to resist kinking, stainless steel ground wire, fuel-resistant neoprene exterior, and nitrile interior. It is compatible with gasoline, diesel, biodiesel up to B20, ethanol up to E15, and kerosene.

The FRH10014 hose is suitable for all electric fuel transfer pumps.



Part Number	Description
WSEFRH10014	1 In X 14 Ft Retail Hose

### Fuel Transfer Hose, 1" x 20'

The Fill-Rite FRH10020 (1" x 20', NPT) fuel transfer hose is constructed with an internal spring guard to resist kinking, stainless steel ground wire, fuel-resistant neoprene exterior, and nitrile interior. It is compatible with gasoline, diesel, biodiesel up to B20, ethanol up to E15, and kerosene.

The FRH10020 hose is suitable for all electric fuel transfer pumps.



Part Number	Description
WSEFRH10020	1 In X 20 Ft Retail Hose

**FILL-RITE**  
PROUDLY MANUFACTURED BY TUTHILL

### Fuel Transfer Hose, 3/4" x 20'

The Fill-Rite FRH07520 (3/4" x 20', NPT) fuel transfer hose is constructed with an internal spring guard to resist kinking, stainless steel ground wire, fuel-resistant neoprene exterior, and nitrile interior. It is compatible with gasoline, diesel, biodiesel up to B20, ethanol up to E15, and kerosene.

The FRH07520 hose is suitable for all electric fuel transfer pumps.



Part Number	Description
WSEFRH07520	3/4 In X 20 Ft Retail Hose

### Arctic Fuel Transfer Hose 3/4" x 15'

The Fill-Rite FRHA07515 (3/4" x 15', NPT) arctic fuel transfer hose is specifically designed for cold weather usage to -40°F/C. The hose is constructed with an internal spring guard to resist kinking, stainless steel ground wire, fuel-resistant neoprene exterior, and nitrile interior. It is compatible with gasoline, diesel, biodiesel up to B20, ethanol up to E15, and kerosene. The FRHA07515 hose is suitable for all electric fuel transfer pumps.

- 3/4" male NPT fittings
- Internal spring guard
- Stainless steel ground wire
- Fuel-resistant neoprene exterior and high-quality nitrile interior



Part Number	Description
WSEFRHA07515	3/4 In X 15 Ft Retail Arctic Fuel Transfer Hose





# Meters



**WSE807CMK** 3-Wheel Mechanical, 3/4 In Meter

## Mechanical 3/4" Meter, Up to 99.9 Litre Digits 807CMK

Fill-Rite's line of easy-to-read, 3-digit mechanical flow meters are designed to meet the stringent demands of customers who need to monitor fuel usage accurately and dependability. Rugged construction, easy to read numbers, and the flexibility of horizontal or vertical positioning are just three features of these superior meters. Plus, all can be field calibrated for the utmost accuracy, regardless of fluid.



**STANDARD FEATURES**

- 5 - 20 GPM
- Large, easy-to-read display
- Robust construction to withstand your harsh applications
- 3/4" inlet and outlet

Part Number	Description
WSE807CMK	3-Wheel Mechanical, 3/4 In Meter

**WSETT10AN** In-Line Digital Turbine Meter

## In-Line Digital Turbine Meter

Accurate within 1%, the Fill-Rite TT10AN In-line Digital Turbine Meter sets the standard for accuracy, ease of use, and safety. It has factory presets for 18 fluids and more safety approvals than any other meter in its class. Replaceable (2) AA batteries.



**STANDARD FEATURES**

- Highly accurate to +/- 1%
- Installation flexibility; can be installed at the pump or at the nozzle for convenient and accurate flow rate visibility
- Protective rubber boot absorbs impact to minimize meter and electronic damage in harsh environments
- Rugged cast aluminum construction; lightweight, durable material offers corrosion resistance and protection from degradation in extreme heat and frigid temperatures (-40° to 176°)
- Instant measurement conversions; measures fluid in ounces, pints, gallons, liters, and quarts at the touch of a button
- Long battery life; powered by included AA batteries that measure up to 300,000 gallons on one charge

Part Number	Description
WSETT10AN	In-Line Digital Turbine Meter

# PRESSURE WASHER HOSE REELS

## HOSE REELS *Heavy Duty Pressure Washer Hose Reels*

### STANDARD FEATURES

- Max. 3000 PSI
- Max. 160°F
- Hose size 3/8"



Part Number	Max Hose	Max Height	Max Width
SPP85.402.050	50'	13"	11.75"
SPP85.402.001	100'	17"	18"
SPP85.402.002	200'	20"	15.75"



## WESTWARD PARTS

6517 - 67 St.  
Red Deer, AB T4P 1A3  
Fax: 1-800-661-4508

201 Henderson Dr.  
Regina, SK S4N 7E2  
Fax: 1-800-721-2977

1435 St. James St.  
Winnipeg, MB R3H 0W9  
Fax: 1-800-257-8338

Specifications subject to change without notice or obligation.



WESTWARDPARTS.COM



1-888-937-7278

# SHOP SUPPLIES



- TUB'O TOWELS
- CAB'N FRESH
- CAR CARE PRODUCTS
- REFRIGERANT & ACCESSORIES



**WESTWARD PARTS**

## Shop Supplies

### Tub O' Towels *The World's Hardest Working Wipes!*

**TUB O'  
TOWELS**

#### BREAK IT DOWN, WIPE IT AWAY!

Once the bond is broken and the dirt dislodged, Tub O' Towels' proprietary, high-performance blend of detergents and emulsifiers goes to work dissolving greases, oils, fats and proteins, enabling cleaning, while foaming agents lift the grime and dirt so it can easily be wiped away. This special synergistic solution is the result of years of testing and trial to create the perfect recipe for optimal wipe performance. It's safe to use on virtually any surface.

#### STANDARD FEATURES

- 90 Count - 10"x12" oversized wipe.
- These heavy-duty cleaning wipes remove even the toughest grease, grime and stains.
- Industrial strength formula removes grease, tar, ink, paint and many other tough messes on hands and most surfaces.
- Extra large wipes with durable fiber weave are bigger, stronger and tougher to ensure maximum durability and performance.
- VaporLock™ canister is made of heavy-gauge plastic with locking lid to minimize solution evaporation.
- Every wipe is 100% solution soaked from the first to the last.
- No harsh chemicals, only biodegradable cleaning agents.



Part No.	Description
MISTW90	Tub of 90 Towels (10" X 12")

### Cab'N Fresh *Scent Pouches*

#### STANDARD FEATURES

- Designed by inventive artists, scientists and engineers who care about the earth.
- 4 scent pouches/box.
- Protects your cab, RV, or building from staleness & odours.
- Long-lasting, slow-release fragrance.
- Each pouch lasts up to 3 months.
- Made from Plant Fibers (Corn Cob); Essential Oils of Cedarwood, Balsam Fir, Lavender & Rosemary; Fragrance.



Part No.	Description
ACCCF1	Cab'N Fresh Scent Pouches (Box of 4 Pouches)

# Shop Supplies

## zytec Germ Buster Hand Sanitizer

*Protection against Germs and Bacteria for the whole family! 70% Alcohol.*

zytec Germ Buster Hand Sanitizers kill harmful bacteria and sanitize hands on contact. Enriched with aloe, vitamin E and additional moisturizers, the clear gel leaves your hands smooth and soft. Available in both a 240 ml travel size or a large 1 litre with multi-use pump, zytec Germ Buster Hand Sanitizers keep you safe and protected throughout the day.

### STANDARD FEATURES

- Gives protection on the go against germs when soap and water are not available.
- Kills microorganisms upon contact and refreshes hands.
- Regular use prevents germ transmission and helps maintain good health.

Part No.	Description
MIS01215	Clear Gel Hand Sanitizer 250ML
MIS01217	Clear Gel Hand Sanitizer 1L

Sold by the case only.



**NEW!**



## Worx All Natural Hand Cleaner

### STANDARD FEATURES

- First Hand Cleaner to Obtain Environmental Certification
- Lift Stains without Damaging, Drying or Cracking Skin
- Neutral PH Balanced, Eliminates Foul Odors
- Helps Prevent Dermatitis & Promotes Healing
- Removes Carbon, Brake Dust, Axle Grease, Graphite, Silicone, Printer's Ink, Adhesives, Gear Grease, Fresh Paint, Varnishes, Fresh Industrial Coatings, Industrial Soils, Lube Oils, Coal Dust, Solvent-Based Adhesive Residue, Glue & more...
- Does Not Contain Microbeads, Walnut Shells, Hars Chemicals or Abrasives.
- Food Safe (CFIA Approved)
- Readily Biodegradable

Part No.	Description
LUB11-1300	Worx All Natural Hand Cleaner 3lb Bottle
LUB11-1450	Worx All Natural Hand Cleaner 4.5lb Bottle



## Shop Supplies

### Sweeping Compound



#### STANDARD FEATURES

- Eliminates excess dust
- Contains 100% Canola Oil
- Does not contain petroleum oil
- 100% environmentally safe
- 20 kg. box

Part No.	Description
HARGSC	Sweeping Compound (20 kg. box)

### Near White Wipers



Part No.	Description
HARRBXN-10C	Near White Wipers (10 lb./pack)

### Microfiber Multipurpose Cloths



#### STANDARD FEATURES

- Colour coded for cleaning programs
- Terry knit construction for dusting, polishing, and soft scrubbing
- Try chemical-free cleaning

Part No.	Description
GHTRMF(C)-1414/10P	14" Microfiber Multipurpose Cloths

### Colour T-Shirt Wipers



#### STANDARD FEATURES

- High cotton content
- Multicolour wipers
- Great for water, oil and grease
- Uniform wiping experience

Part No.	Description
GHTFX-8C	Colour T-Shirt Wipers

### 3 Gallon Rubber Pan

#### STANDARD FEATURES

- Crush-proof, crack-proof, and freeze-proof so it can be used outside year-round.
- Great all-purpose tubs that hold up to rugged use and abuse.
- Naturally safe and soft for animals.
- Great for many jobs around the farm, ranch, garden and shop.



Part No.	Description
MIS03C	3 Gallon Rubber Pan

# Car Care Products



## Ammonia Fortified Glass Cleaner

Aerosol emzone GLASS CLEANER ammonia fortified extra-strength formula thoroughly cleans glass surfaces quickly removing stubborn dirt, grease, and grime. Do not use on tinted windows. Can be used on all surfaces at home or the office.  
517 g / 18.2 oz



Part No.	Description
ACC44003	Ammonia Fortified Glass Cleaner

## Foaming Glass Cleaner

Aerosol emzone FOAMING GLASS CLEANER industrial strength, non-drip formula cleans glass surfaces quickly removing bugs, dirt and grime. Dries fast and never leaves streaks, smears or residue behind. Safe for tinted windows.  
517 g / 18.2 oz



Part No.	Description
ACC44005	Foaming Glass Cleaner

## Carpet & Upholstery Foaming Cleaner

Aerosol emzone CARPET & UPHOLSTERY FOAMING CLEANER Stain fighting formula quickly cleans carpets, fabric, and vinyl. Deep cleaning foam gently lifts and removes grease, dirt, and stains without saturating. Dries quickly without leaving any residue to pre-vent re-soiling. Ideal for carpets, floor mats, and upholstery including seats.  
500 g / 18 oz



Part No.	Description
ACC44016	Carpet & Upholstery Foaming Cleaner

## Foaming Tire Shine

Aerosol emzone FOAMING TIRE SHINE cleans, shines and protects your tires in one easy step. No wiping, no rubbing, no mess! Just spray and walk away. Our special formula lifts and dissolves dirt leaving your tires with a high gloss finish.  
500 g / 18 oz



Part No.	Description
ACC44018	Foaming Tire Shine

## Ultimate Shine

Aerosol emzone ULTIMATE SHINE beautifies, renews and protects surfaces providing a rich, gloss shine on vinyl, leather, rubber and plastic. Use to shine and protect dashboards, air vents, doors and truck seats. Our UV anti-static formula repels dust and protects against UV rays. Ideal for cars, boats and trucks.  
400 g / 14 oz



Part No.	Description
ACC44019	Ultimate Shine

## Rim Protector

Aerosol emzone RIM PROTECTOR forms an invisible protective barrier that repels brake dust, road grime, grease and dirt. It prevents brake dust and grime from sticking to the surface, which keeps rims clean longer and makes cleaning easier. One application lasts up to 4 weeks.  
227 g / 8 oz



Part No.	Description
ACC44033	Rim Protector

## Rim Cleaner

Pump Spray emzone RIM CLEANER aggressively cleans and dissolves brake dust, road grime, grease and dirt to leave your rims with a brilliant shine.  
650 mL / 22 fl oz



Part No.	Description
ACC44034	Rim Cleaner

## Car Care Products

### Bug & Tar Remover

Aerosol emzone BUG & TAR REMOVER is specially formulated to dissolve, lift and remove difficult to clean tar, bugs, tree sap and grease from the body of your car. It is easy to apply and clean off, is clear coat safe and leaves the surface of your car smooth and shiny.

487 g / 17.2 oz



Part No.	Description
ACC44035	Bug & Tar Remover

### Waterless Wash & Wax

Aerosol emzone WATERLESS WASH & WAX will wash and wax your vehicle, boat or truck without water in two easy steps. Spray and wipe then buff. Our Carnuba Wax formula offers a superior shine and protection. As well, our innovative formula offers protection from UV rays and repels dirt and dust. Our deep cleaning agents lift and remove tar, bugs, grease and dirt. Silicone and Teflon free. Ideal for cars, boats, trucks, RVs and can be used on other household surfaces. Use on body, rims, glass and mirrors including metal, aluminum, stainless steel, plastic and fiberglass surfaces.

496 g / 17.5 oz



Part No.	Description
ACC44038	Waterless Wash & Wax

### Salt & Stain Remover

Aerosolemzone SALT & STAIN REMOVER is specially formulated to deep clean, break up and remove stubborn salt and other stains from your car's interior without water. Ideal for floor mats, carpets, seats and upholstery. 425 g / 15 oz



Part No.	Description
ACC44039	Salt & Stain Remover



### Leather Cleaner & Conditioner

Lotion emzone LEATHER CLEANER & CONDITIONER is specially formulated to clean, nourish, and hydrate your leather all in one step! It contains no harsh ingredients that can damage, discolor or dull leather. It is strong enough for tough jobs but gentle enough for the finest leather.

375 mL / 12.7 fl oz



Part No.	Description
ACC44061	Leather Cleaner & Conditioner

### OdorStop

Aerosol OdorStop odor neutralizer is designed to tackle tough problems due to moisture accumulation in vehicle vent and A/C systems. Excellent for eliminating odors caused by cigarette smoke, mildew and mold by attacking the problem at the source, circulating throughout the entire system. One time use (total release).

156 g / 5.5 oz



Part No.	Description
ACC44210	OdorStop

### OdorStop Fabric Refresher

Pump Spray OdorStop Fabric Refresher is designed to eliminate odors and freshen fabrics, carpets and air in your car.

275 mL / 9.3 fl oz



Part No.	Description
ACC44225	OdorStop Fabric Refresher





# Car Care Products

## Engine Shampoo

Aerosol emzone ENGINE SHAMPOO heavy duty degreaser cleans heavy grease, dirt and oil deposits on engines. Ideal for use on automobiles, trucks, power mowers, boats, tractors and industrial machinery. 446 g / 15.7 oz



Part No.	Description
ACC45001	Engine Shampoo

## White Lithium Grease

Aerosol emzone WHITE LITHIUM GREASE is a high performance grease which lubricates parts and metal while protecting against rust. Withstands high heat and is water resistant. Ideal for home and the office. Safe on most paints and plastics. Silicone free. 400 g / 14 oz



Part No.	Description
ACC45007	White Lithium Grease

## Penetrating Lubricant

Aerosol emzone PENETRATING LUBRICANT is a high strength, fast acting lubricant. Loosens and lubricates tight or sticky parts. Ideal for use on bolts, nuts, hinges, locks, tools and rollers. Stops squeaks. Displaces moisture and helps prevent rust. 400 g / 14 oz



Part No.	Description
ACC45002	Penetrating Lubricant

## Gravel Guard Undercoating

Aerosol emzone GRAVEL GUARD UNDERCOATING is a tough, flexible, textured black coating that provides protection against road abrasion and weathering. It is paintable and offers excellent adhesion to metals and plastics. Superior protection against rust, corrosion, moisture and abrasion. Quickly dries to a flexible, textured surface. Professionally formulated to be tough, durable and long-lasting. Reduces road noises and vibrations. Ideal for rocker panels, wheel wells and underbody. Silicone free. 446 g / 15.7 oz



Part No.	Description
ACC45008	Gravel Guard Undercoating

## Silicone Lube

Aerosol emzone SILICONE LUBE contains 100% pure high viscosity silicone. Lubricates, stops squeaks and prevents rust. Prevents rubber from freezing and sticking to metal, while keeping it flexible. Helps rustproof tools and barbecues. 300 g / 10.6 oz



Part No.	Description
ACC45006	Silicone Lube

## Air Intake Carb & Choke Cleaner

Aerosol emzone AIR INTAKE CARB & CHOKE CLEANER effectively cleans dirt, gum and varnish from carburetors, fuel injection throttle bodies, air intakes, automatic chokes, PCV valves and throttle linkage. 418 g / 14.7 oz



Part No.	Description
ACC45009	Air Intake Carb & Choke Cleaner

## Car Care Products

### Corrosion Guard

Aerosolemzone CORROSION GUARD is a multi-purpose lubricant and rust inhibitor. Protects metals from rust, keeps moving parts and mechanisms well-lubricated, penetrates to loosen seized parts and inhibits corrosion in vulnerable crevice areas. Displaces moisture. Great for do-it-yourself automobile corrosion protection or touch-ups of rust-proofed vehicles.



Part No.	Description
ACC45021	Corrosion Guard

### Tech Lube

Aerosolemzone TECH LUBE lubricant film offers long lasting protection with corrosion and rust inhibitors. It penetrates the surface and offers a strong, durable, and lasting barrier, with a non-drip formula that will not evaporate, will not dry, and repels water. Silicone free and solvent free. Will not harm plastic, painted surfaces or synthetic rubber materials.  
320 g / 11.4 oz



Part No.	Description
ACC45024	Tech Lube

### Pro-Tex No Drip Oil

Aerosolemzone PRO-TEX NO DRIP OIL is a long lasting, water resistant lubricant and rust inhibitor. Coats and protects metals from rust, keeps moving parts and mechanisms well lubricated, penetrates to loosen seized parts, and inhibits rust in vulnerable crevice areas. Effective corrosion protection for outdoor equipment. Ideal for do-it-yourself vehicle undercoating and protecting battery terminals. Use to protect equipment for winter storage. Silicone and solvent free.  
Oil 400 g / 14 oz



Part No.	Description
ACC45025	Pro-Tex No Drip Oil



### Penetrating Foam

Aerosol emzone PENETRATING FOAM penetrates through rust and surfaces to allow tight or sticky parts to be loosened. This No Drip foam formula lubricates and protects surfaces against rust. Repels water and displaces moisture. 360° valve allows spraying from any angle  
445 g / 15.7 oz



Part No.	Description
ACC45028	Penetrating Foam

### The BIG Can - Brake & Parts Cleaner (Non-Chlorinated)

emzone BRAKE & PARTS CLEANER is an advanced formulation of cleaning solvents that quickly dissolve and remove grease, oil, brake fluid, road grime and dirt from brake parts, CV joints, disc pads, drums and other components. Helps reduce brake squeal. No residue. Fast drying. Low Odour. High pressure delivery. For professional use only.  
482 g / 17 oz Aerosol



Part No.	Description
ACC45046	The BIG Can - Brake & Parts Cleaner (Non-Chlorinated)

# Refrigerant & Accessories



## 12A A/C Cool Refrigerant

emzone 12A A/C Cool Refrigerant is an environmentally friendly replacement alternative for ozone depleting R-12 and global warming R134a products. It is non-toxic and non-ozone depleting. The 12A A/C Cool Refrigerant also contains high performance oil to improve system efficiency and Universal UV Dye to help with leak detection.



Part No.	Description
ACCHC12A-6	12A A/C Cool Refrigerant

## 12A A/C Refrigerant Cylinder

emzone 12A A/C Cool Refrigerant is an environmentally friendly replacement alternative for ozone depleting R-12 and global warming R134a products. It is non-toxic and non-ozone depleting. The 12A A/C Cool Refrigerant also contains high performance oil to improve system efficiency and is system safe.



Part No.	Description
ACCHC12A-30	12A A/C Refrigerant Cylinder

## 1/2" Valve Recharge Hose w/Gauge

The heavy duty Recharge Hose with Pressure Gauge is suitable for all emzone Refrigerant, Stop Leak and associated products. Use to determine current pressure status of A/C system and ensure accuracy when recharging. The durable brass connectors ensure a safe and secure fit. Includes R134a quick connect. Compatible with R-12 adaptors and A/C Retrofit Conversion Fittings (sold separately).



Part No.	Description
ACC45715	1/2" Valve Recharge Hose w/Gauge-13"/33 cm

## 12A A/C Deluxe Recharge & Sealant Kit

This emzone kit contains the necessary items to recharge and seal an A/C system efficiently and safely.

This emzone kit contains:

- 2 emzone 12A A/C Cool Refrigerants
- 1 emzone 12A A/C Stop Leak
- 1 Deluxe Recharge Hose (Brass)
- A/C Retrofit Conversion Fitting
- A/C Refrigerant Oil Tester



Part No.	Description
ACC45883	12A A/C Deluxe Recharge & Sealant Kit

## 12A A/C Recharge Kit including Hose with Gauge

This emzone kit contains the necessary items to recharge an A/C system efficiently and safely.

This emzone kit contains:

- 2 emzone 12A A/C Cool Refrigerants
- 1 Recharge Hose with Gauge
- A/C Retrofit Conversion Fitting
- A/C Refrigerant Oil Tester



Part No.	Description
ACC45885	12A A/C Recharge Kit including Hose w/Gauge

## 1/2" Valve Recharge Hose

The heavy duty Recharge Hose is suitable for all emzone Refrigerant, Stop Leak and associated products. The durable brass connectors ensure a safe and secure fit and includes R134a quick connect. Compatible with R-12 adaptors and A/C Retrofit Conversion Fittings (sold separately).



Part No.	Description
ACC45713	1/2" Valve Recharge Hose (Brass) - 13"/33cm

## A/C Retrofit Conversion Fitting

A/C Retrofit Conversion Fittings low side adaptor allows for the servicing of older mobile A/C systems and is to be used on the low side A/C service port.



Part No.	Description
ACC45554	A/C Retrofit Conversion Fitting

## Refrigerant & Accessories

### 12A A/C Oil Charge

emzone 12A A/C Oil Charge is a universal lubricant and conditioner designed to reduce friction, replace lost oil due to leaks, and increase compressor life. It is safe for all systems and will not clog or restrict flow.



Part No.	Description
ACC45852	12A A/C Oil Charge

### 12A A/C System Conditioner

emzone 12A A/C System Conditioner repairs and conditions rubber parts including O-ring seals and gasket joints. It also improves system efficiency and helps prevent leaks in these areas. The 12A A/C System Conditioner is safe for all systems and will not clog or restrict flow.



Part No.	Description
ACC45855	12A A/C System Conditioner

### 12A A/C Stop Leak

emzone 12A A/C Stop Leak seals leaks permanently in metal and rubber parts, including evaporators, condensers, driers, O-rings, and gasket joints. It also improves system efficiency and prevents future leaks. The emzone 12A A/C Stop Leak is safe for all systems and will not clog or restrict flow. The 114 g can contains sufficient stop leak to stop minor leaks in 2 lb. to 5 lb. A/C systems.



Part No.	Description
ACC45856	12A A/C Stop Leak



### 12A A/C All-In-One

emzone 12A A/C All-In-One is a multi-purpose product containing: UV Dye for leak detection, Oil Charge universal lubricant, and System Conditioner for O-ring seals. It also helps detect leaks, lubricate A/C systems and repair leaks in O-rings and gasket joints and is system safe.



Part No.	Description
ACC45857	12A A/C All-In-One

### Air Duster

emzone Air Dusters blast away dust, dirt and lint from computers, electronics, office equipment, and automobiles including keyboards, printers, cameras, CD/DVD/blu-ray players, telephones, photo copiers, and dashboards. emzone Air Dusters are great for hard to reach areas.



Part No.	Description
ACC47020	Air Duster

### Signal Air Horn

The high-performance emzone Signal Air Horn produces loud blasts and is the ideal size for boats, construction sites, industrial use, and sporting events.

- Easy to use and hold
- Over 120 decibel volume
- Audible horn can be heard over a mile
- Non-Flammable



Part No.	Description
ACC46100	Signal Air Horn 227g

# Brinks Padlocks

**50mm Solid Brass Padlock with Boron Shackle**



Part No.	Description
ACC671-50001	50mm Solid Brass Padlock

**50mm Solid Brass Padlock with Adjustable Shackle**



Part No.	Description
ACC671-50061	50mm Solid Brass Padlock w/ Adj. Shackle

**63.5mm Commercial Solid Steel Padlock**



Part No.	Description
ACC672-52701	63.5mm Commercial Solid Steel Padlock

**50mm Commercial Laminated Steel Padlock**



Part No.	Description
ACC672-50001	50mm Commercial Laminated Steel Padlock

**70mm Commercial Stainless Steel Discus**



Part No.	Description
ACC673-70001	70mm Commercial Stainless Steel Discus

**50mm Commercial Laminated Steel Padlock with 2 Inch Shackle**



Part No.	Description
ACC672-52001	50mm Commercial Laminated Steel Padlock with 2 Inch Shackle

**50mm Commercial Weather Resistant Padlock With 2 Inch Shackle**



Part No.	Description
ACC677-52051	50mm Commercial Weather Resistant Padlock With 2 Inch Shackle

**60mm Commercial Laminated Steel Padlock**



Part No.	Description
ACC672-60001	60mm Commercial Laminated Steel Padlock

## Tie-Down Assortment Kit

**NEW!**
**Buy the Full Kit or Individual Parts**

Presenting the Keeper® Brand. The broadest assortment of high-quality Cargo Control products available. Cargo Control Products include Tie-Downs, Bungee, Truck & Trailer Accessories, Towing/Towing Security, Electric Winches and more.

For over 36 years, the Keeper® brand has grown to continually meet the demands of a changing marketplace; improving cargo handling and helping mold the way the world transports cargo.

Part No.	Description
ACC19001	Tie-Down Assortment Kit (Kit includes products only - display stand & signs not included)

ACC19001 includes the following merchandiser assortment:

Part No.	Description	Qty.
ACC5510	*No 1 - Keeper 12' High Tension Ratchet Tie-Down, 4 Pack	2
ACC47352	*No 2 - Keeper 16' Ratchet Tie-Down, 2 Pack	2
ACC5521	*No. 3 - Keeper 15' High Tension Ratchet Tie-Down	2
ACC5506	*No. 4 - Keeper 15' High Tension Ratchet Tie-Down, 4 Pack	2
ACC45518	*No. 5 - Keeper 15' High Tension Ratchet, 2 Pack	2
ACC5524	*No. 6 - Keeper 14' High Tension Ratchet Tie-Down	2
ACC03508-V	*No. 7 - Keeper 8' Camo Ratchet Tie-Down, 4 Pack	2
ACC47310	*No. 8 - Keeper 10' Ergo-Torque Ratchet Tie-Down, 2 Pack	2
ACC45545	*No. 9 - Keeper 12' Industrial Ratchet Tie-Down	2
ACC5105	*No. 10 - Keeper 10' Cam Buckle Tie-Down, 4 Pack	2
ACC45721	*No. 11 - Keeper 8' Ratchet Tie-Down, 2 Pack	2
ACC85515	*No. 12 - Keeper 16' High Tension Ratchet Tie-Down	2
ACC4622	*No. 13 - Keeper 27' Heavy-Duty Ratchet Tie-Down	2
ACC47202-0	*No. 14 - Keeper 16' Ratchet Tie-Down, Chrome	6
ACC47205	*No. 15 - Keeper 14' Ratchet Tie-Down, Black	6

\*No. refers to the display photo



# Bungee Cords



Buy the Full Kit + Display or Individual Parts

## Bungee Display, Coated Hooks, 50 Pcs w/ Rack

Includes the following merchandiser assortment:

Part No.	Description	Qty
ACC9213	Bungee Display, Coated Hooks, 50 Pcs w/Rack	1
ACC6014	Keeper 13" Vinyl Coated Bungee Cord	10
ACC6019	Keeper 18" Vinyl Coated Bungee Cord	10
ACC6025	Keeper 24" Vinyl Coated Bungee Cord	10
ACC6031	Keeper 30" Vinyl Coated Bungee Cord	10
ACC6037	Keeper 36" Vinyl Coated Bungee Cord	10



## Rubber Display, EPDM, 50 Pcs. w/ Rack

Includes the following merchandiser assortment:

Part No.	Description	Qty
ACC9214	Rubber Display, EPDM, 50 Pcs. w/Rack	1
ACC6214	*No 1 - Keeper 12' High Tension Ratchet Tie-Down, 4 Pack	10
ACC6219	*No 2 - Keeper 16' Ratchet Tie-Down, 2 Pack	10
ACC6224	Keeper 24" EPDM Rubber Strap	10
ACC6235	Keeper 35" EPDM Rubber Strap	10
ACC6245	Keeper 45" EPDM Rubber Strap	10



## Bungee Display, Heavy Duty, 50 Pcs w/ Rack

Includes the following merchandiser assortment:

Part No.	Description	Qty
ACC9216	Bungee Display, Heavy Duty, 50 Pcs w/Rack	1
ACC6192	Keeper Bungee Cord, 18" Heavy Duty	10
ACC6180	Keeper Bungee Cord, 24" Heavy Duty	10
ACC6182	Keeper Bungee Cord, 32" Heavy Duty	10
ACC6185	Keeper Bungee Cord, 40" Heavy Duty	10
ACC6188	Keeper Bungee Cord, 48" Heavy Duty	10



## WIPECO Gloves

### High Dexterity - Orange

High Dexterity, seamless high visibility orange nylon, knit liner with black foam latex coating.



Part Number	Description
GHTLNG-O8	Grip Gloves - High Vis. Orange - 8
GHTLNG-O10	Grip Gloves - High Vis. Orange - 10
GHTLNG-O11	Grip Gloves - High Vis. Orange - 11

### High Dexterity - Blue

High Dexterity, seamless blue nylon, knit liner with black foam latex coating.



Part Number	Description
GHTLNG-B8	Grip Gloves Blue - 8
GHTLNG-B10	Grip Gloves Blue - 10
GHTLNG-B11	Grip Gloves Blue - 11

### Winter Gripper

Seamless blue nylon knit shell with 7 gauge heavy acrylic terry liner and 3/4 dip latex foam. Flexible in extreme temperatures. Superior comfort. Great wet & dry grip.



Part Number	Description
GHTLNG-W8B	Winter Grip Gloves Blue - 8
GHTLNG-W10B	Winter Grip Gloves Blue - 10
GHTLNG-W11B	Winter Grip Gloves Blue - 11

### Industrial Grade Cowhide

Industrial grade cowhide grain leather fitters, with patch palm construction and rubberized safety cuff.

**NEW!**

Part Number	Description
GHTFC20-9	Industrial Cowhide Gloves - 9
GHTFC20-10	Industrial Cowhide Gloves - 10
GHTFC20-11	Industrial Cowhide Gloves - 11

### Premium Grade Cowhide

Premium grade cowhide grain leather fitters, with full palm, knuckle strap and index finger construction. Plush pile liner and elastized cuff.



Part Number	Description
GHTFC32-11P	Premium Cowhide Gloves

### Premium Goatskin

Premium goatskin grain leather drivers with inset thumb and C100 Thinsulate, and elastized cuff.



Part Number	Description
GHTDGS-9TH	Premium Goatskin Gloves- 9
GHTDGS-10TH	Premium Goatskin Gloves- 10
GHTDGS-11TH	Premium Goatskin Gloves- 11



*Westward Parts offers the most comprehensive range of products to meet the needs of all agricultural and industrial customers.*



## Agriculture Parts

- Bearings, Seals, Flanges, O-Rings
- 3 Point Hitch Parts or Tillage Tools
- PTO Drives, Adapters, Yokes, Crosses
- Canvas, Swather Parts, Canvas Repair
- Combine Repair Parts
- Harrow Parts, Pickup & Harrow Tines
- Pickup Reel Parts
- Cutting Parts & Guards, Ag Accessories

## Sprayer Parts

- Pumps & Couplers
- Valves, Manual & Electric
- Tips, Strainers, Filters
- Nozzle Bodies, Caps, Boom Clamps
- Hose, Fittings, Cam Locks
- Handguns
- Pressure Washer Parts
- Booms, Tanks, Accessories



## Estate Equipment

- Cameras & Accessories
- Fencing Equipment
- Hay & Bale Handling Equipment
- Lawn & Garden
- Material Movement
- Estate Sprayers & Accessories
- Tillage Equipment
- Water, Transfer & Trash Pumps



## Industrial Parts

- Chain, V-Belts, Chain Tools
- Bearings, Seals, Flanges, O-Rings
- Sheaves, Pulleys, Sprockets, Weld-ons
- Hardware, Drawpins, Wire Rope, Lubricants
- PTO Drives, Adapters, Yokes, Crosses
- Hubs, Wheels, Spindles, Casters
- Belting Seals and Shields
- Hydraulic Fittings, Couplers, Cylinders



**1-888-937-7278**



For over 48 years, Westward Parts continues to be  
the premier provider of Quality Agricultural Parts  
and Equipment in Western Canada.

[www.westwardparts.com](http://www.westwardparts.com)

**1-888-937-7278**

***Westward has the part!***